

## SERIMUX® Series

# SERIMUX-CS-x

## CONSOLE SWITCH

### Installation and Operation Manual

---



## TRADEMARK

SERIMUX is a registered trademark of Network Technologies Inc in the U.S. and other countries.

## COPYRIGHT

Copyright © 2004-2019 by Network Technologies Inc. All rights reserved. No part of this publication may be reproduced, stored in a retrieval system, or transmitted, in any form or by any means, electronic, mechanical, photocopying, recording, or otherwise, without the prior written consent of Network Technologies Inc, 1275 Danner Drive, Aurora, Ohio 44202.

## CHANGES

The material in this guide is for information only and is subject to change without notice. Network Technologies Inc reserves the right to make changes in the product design without reservation and without notification to its users.

## FIRMWARE VERSION

Switch Firmware Version-1.14

Web Interface Version-1.10

## Typographic Conventions

The table below offers examples of text format and the meaning when that format is used when the font varies from the standard font (Helvetica) used in this manual.

Typeface meaning	Font Configuration	Example
On-screen computer output	Courier New-(not bold)	C:>
<b>What you type on the computer</b>	<b>Courier New-bold</b>	C:> <b>edit text.bat</b>
Command line placeholder-(something the user must replace with a name or value)	<i>Courier- Italic</i>	C:> <b>edit</b> %filename%
Characters to be typed as instructed in the body of a paragraph	<b>Courier New-bold</b> <b>Surrounded by &lt; &gt;</b>	<L>

# TABLE OF CONTENTS

<b>Introduction</b> .....	<b>1</b>
Materials .....	1
Serial Interface Specifications .....	2
Supported Web Browsers .....	2
Definitions.....	2
<b>Default User Name and Passwords</b> .....	<b>3</b>
<b>Features and Functions</b> .....	<b>4</b>
<b>Installation</b> .....	<b>5</b>
To Mount to a Rack .....	5
Cable Connections .....	6
Connect to the Ethernet .....	6
Dual Power Option .....	7
<b>Initial Startup</b> .....	<b>8</b>
SERIMUX Quick Start .....	8
<b>Using the SERIMUX Console Switch</b> .....	<b>9</b>
<b>Serial Control- Administrator</b> .....	<b>9</b>
Login as the administrator .....	10
Port List .....	11
Port Settings.....	12
Port serial settings .....	14
Baud rate .....	14
Data bit .....	14
Stop Bit .....	14
Parity.....	14
Flow Control.....	14
Xon or Xoff Characters .....	15
DTR line behavior.....	15
Inter-character delay.....	15
Line-break receive or transmit.....	15
Copy Port Serial Settings .....	16
Display serial settings for different port number.....	16
Modem settings.....	16
Port data buffer .....	17
Clear Port data buffer .....	18
User List .....	18
User Settings .....	19
Port access .....	20
Copy User Settings.....	20
Advanced Settings.....	21
Change administrator password .....	21
Firmware .....	22
Load new firmware .....	22
Save current firmware .....	22
Network Settings.....	23
Reboot .....	24
<b>Serial control-Users</b> .....	<b>25</b>
User "Accessible host list" screen .....	25
User main menu .....	26
Port List screen.....	27
User Terse mode.....	28
Terse mode commands .....	28
Firmware Upgrade.....	30
<b>Keypad Control</b> .....	<b>32</b>
Functions of the Keypad.....	32
Login the administrator .....	32
Disconnect the administrator or a user with administrative privileges.....	33
Login a user to the administrator main menu .....	33

Login user to a port.....	33
Login user to a port and connect the user port to a host port.....	34
Disconnect and logout a user .....	34
Connect 2 host ports.....	34
Disconnect 2 ports .....	35
Attach or detach a modem.....	35
Reset SERIMUX Console Switch to default settings .....	35
<b>Web Interface.....</b>	<b>36</b>
Enter the Password .....	36
Port Configuration.....	37
Port List Page .....	37
Disconnect Port Page .....	37
Connect Two Host Ports.....	38
Clear Port Buffer .....	39
Port Settings .....	39
Serial Settings.....	40
Modem Settings.....	42
Copy Port Settings.....	43
User Management.....	44
User List.....	44
Disconnect User.....	44
User Settings .....	45
Copy User Settings.....	46
Administrative Settings.....	47
Admin Config .....	47
Change Admin Password .....	47
Auto Login User .....	48
Telnet Base Port .....	49
Firmware Update .....	50
Network Settings .....	51
Enterprise Settings.....	51
IP Configuration .....	51
Support .....	52
Reboot .....	52
Logout.....	52
<b>Device Discovery Tool.....</b>	<b>53</b>
<b>Command Line Interface .....</b>	<b>54</b>
Helpful Hints .....	56
Update Firmware from CLI .....	57
<b>RESET Button.....</b>	<b>58</b>
<b>Interconnection Cable Wiring Method .....</b>	<b>59</b>
<b>Troubleshooting .....</b>	<b>59</b>
<b>Specifications .....</b>	<b>63</b>
<b>Index .....</b>	<b>64</b>
<b>Warranty Information.....</b>	<b>64</b>

## TABLE OF FIGURES

Figure 1- Secure rackmount ears to switch.....	5
Figure 2- Secure switch to a rack .....	5
Figure 3- Connect terminals and devices to SERIMUX Console Switch.....	6
Figure 4- Connect the LAN to the SERIMUX.....	6
Figure 5- Power connections for SERIMUX with Dual Power option .....	7
Figure 6- Startup- Accessible host list .....	8
Figure 7- Administrator main menu.....	10
Figure 8- The Port list displays the status of all ports .....	11
Figure 9- The Port settings menu .....	12
Figure 10- Control Codes for in-band disconnect sequence .....	13
Figure 11- Port serial settings menu .....	14

Figure 12- Modem settings menu .....	16
Figure 13- Port data buffer .....	17
Figure 14- User List .....	18
Figure 15- User settings menu.....	19
Figure 16- Port access list for User 01 .....	20
Figure 17- Administrator's Advanced settings menu.....	21
Figure 18- Firmware menu.....	22
Figure 19- The SERIMUX is waiting to save its firmware.....	23
Figure 20- Network Settings menu .....	23
Figure 21- Reboot SERIMUX from console port connection.....	24
Figure 22- A user with limited host port access .....	25
Figure 23- User main menu .....	26
Figure 24- A limited user accessible Port list .....	27
Figure 25- User port in Terse mode.....	28
Figure 26- Firmware upload window.....	30
Figure 27- Type "AT" to auto-detect baud rate .....	30
Figure 28- Last confirmation before firmware update .....	31
Figure 29- File transfer in progress.....	31
Figure 30- Keypad and LEDs.....	32
Figure 31- Web interface Welcome page.....	36
Figure 32- Web interface Login Prompt .....	36
Figure 34- Port List page .....	37
Figure 35- Disconnect Port page .....	37
Figure 36- Connect Two Host Ports page.....	38
Figure 37- Clear Port Buffers page .....	39
Figure 38- Port Settings page .....	39
Figure 39- Change Port Settings page.....	40
Figure 40- Serial Settings page .....	40
Figure 41- Change Serial Settings page.....	41
Figure 42- Modem Settings page.....	42
Figure 43- Change Modem Settings page .....	42
Figure 44- Copy Port Settings page.....	43
Figure 45- User List page .....	44
Figure 46- User Disconnect page .....	44
Figure 47- Change User Settings page.....	45
Figure 48- Change User Settings page.....	45
Figure 49- Copy User Settings page.....	46
Figure 50- Unit Settings page .....	47
Figure 51- Change Admin Password page .....	47
Figure 52- Auto Login User page.....	48
Figure 53- Telnet Base Port page.....	49
Figure 54- Firmware Update page .....	50
Figure 55- Network Setup-Enterprise Settings page.....	51
Figure 56- Network Setup- Network Settings page .....	51
Figure 57- Support page.....	52
Figure 58- Reboot the SERIMUX from the Web Interface .....	52
Figure 59- Device Discovered.....	53
Figure 60- Command Line Interface login.....	54
Figure 61- List of CLI commands.....	54
Figure 62- Sample txt files for configuring Port 16 .....	56
Figure 63- Location of RESET button .....	58
Figure 64- View looking into RJ45 female.....	59

## APPENDICES

Appendix A - SERIMUX Port Characteristics.....	60
<b>Appendix B - SERIMUX User and Administrator Characteristics .....</b>	<b>60</b>
<b>Appendix C- Cable Adapters .....</b>	<b>61</b>

## INTRODUCTION

The NTI SERIMUX-CS-x Console Switch is a serial port router that allows links (or connections) between multiple pairs of RS232 asynchronous serial ports. The SERIMUX-CS-x (x=4,8,16,24, or 32) is available with up to 32 serial port connections. The main purpose of the switch is to enable users to manage several serial devices from local or remote locations (using external modems). Devices include routers, DSU's, servers, switches or any other equipment allowing serial operation using RS232 interface. Users can work locally using a VT100 or ANSI serial console or a CPU with a terminal program (i.e. HyperTerminal) or from remote locations via optional Ethernet connection.

Each SERIMUX port has to be configured for serial communication (baud rate, parity, etc) within the specifications of the attached serial device, but the configurations of the two devices linked by the SERIMUX do not need to match. Various parameters (communication speed, hardware and/or software flow control, timeout, etc) can be selected for each SERIMUX port. Devices may be either locally connected or connected through attached modems.

Each SERIMUX port can be configured as either a host or user port. Serial hosts (such as servers, switches etc.) are connected to host ports, while serial user devices (such as a terminal or serial console) are connected to user ports.

The SERIMUX Console Switch supports two operator levels: user and administrator. Users login at user ports and connect to serial devices attached at host ports. The administrator (logged in at any user port) and users with administrative privileges can see and/or modify various port or user parameters.

### Option:

- **Ethernet Option-** includes an Ethernet port for controlling the SERIMUX using a WEB interface or Command Line Interface via a Local Area Network (LAN)- to order, add an "E" to the part number (i.e. SERIMUX-CS-xE)
- **Dual Power Option-** includes a second power connector for a secondary power supply cable- to order, add a "DP" to the part number (i.e. SERIMUX-CS-xDP)

## Materials

### Materials Supplied with this kit:

- SERIMUX Console Switch
- 4-#10-32 x 3/4" pan head screws and #10-32 cage nuts (server cabinet mounting hardware)
- Rackmount ears kit
- Power cord, country specific (2-power cords with Dual Power option only)
- DB25F-RJ45F Console Adapter RJ45-DB25 Female
- DB25M-RJ45F-T Console Adapter RJ45-DB25 Male
- DB25M-RJ45F-C Modem Adapter RJ45- DB25 Male
- DB9F-RJ45F Serial Adapter RJ45-DB9 Female
- RJ45MF-RS232-CO Serial Crossover Adapter

### Materials Required but not supplied:

Serial cable with at least one RJ45 male end for connection to the Console Switch from each device to be connected. See Interconnection Cable Wiring Method on page 59 for cable pinout.

## Serial Interface Specifications

- Number of ports: 5, 9, 17, 25 or 33 RS232 ports;
- Connectors: RJ45 male
- Data: asynchronous, 5, 6, 7, or 8 bits per character,
- Parity: even, odd, or none
- Stop Bits: 1, 1 ½, or 2 bits
- Flow Control: Xon/Xoff, RTS/CTS, Both, or None
- Baud Rate: 50 bps to 128,000 bps

## Supported Web Browsers

Most modern web browsers should be supported. The following browsers have been tested:

- Microsoft Internet Explorer 6.0 or higher
- Mozilla FireFox 0.9.2 or higher
- Opera 9.0 or higher

Set your browser to always check if there is a newer version of the page than the version stored in cache. This action will ensure that it will display the most up-to-date information.

## Definitions

device	equipment that can transmit and/or receive data using RS232 interface
inactivity	when a port is not receiving data from the device connected to it
terminal program	a terminal emulation program- computer program that communicates via RS232 interface (i.e. HyperTerminal)
"dumb" terminal	Serial terminal device or CPU terminal program that emulates a serial terminal
timeout	time period of inactivity after which a port will be disconnected (the inter-port connection will be broken)
Baud rate	serial device or port receiver and transmitter speed; measured in "bps" (bits per second)
Flow control	a method to temporarily stop and restart serial data transfer (flow). It can be <ul style="list-style-type: none"> <li>- Hardware (out-band)- usually using the RTS and CTS physical handshaking signals;</li> <li>- Software (in-band)- using special characters, usually named Xon and Xoff, inserted in data being transferred;</li> <li>- Both</li> </ul>
Disconnect sequence	1 or 3 char sequence inserted in the serial data flow, to disconnect the user from the attached serial device and to return to the initial user menu.
[CR]	"Carriage Return" character, ASCII code 13
[LF]	"Line Feed" character, ASCII code 10
[FF]	"Form Feed" character, ASCII code 09
+	(i.e. [ Shift ] + [ < ] ) press the keys simultaneously
-	(i.e. [ P ] - [ 0 ] ) press the P and 0 keys consecutively

## DEFAULT USER NAME AND PASSWORDS

The default Web Interface user name is **root** (lower case letters only).

The default Web Interface password is **nti** (lower case letters only). For instruction on using the Web Interface, see page **36**.

The default Keypad PIN number is **9999 (or 4444 for SERIMUX-CS-4)** . For more on Keypad Control, see page 32.



### Front View of SERIMUX

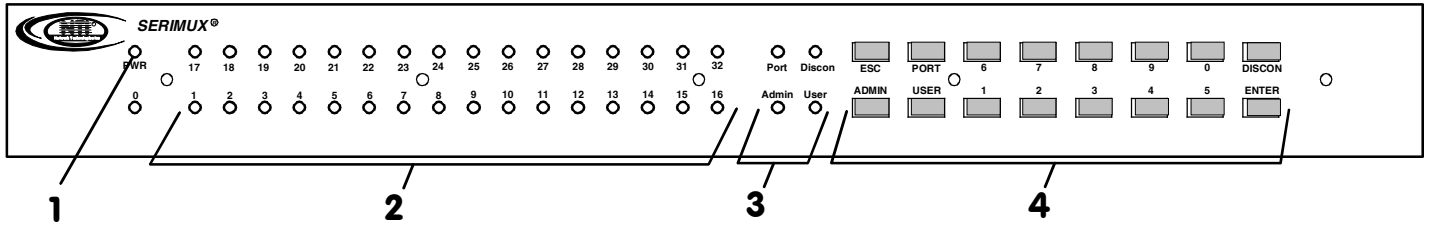

### Rear View of SERIMUX

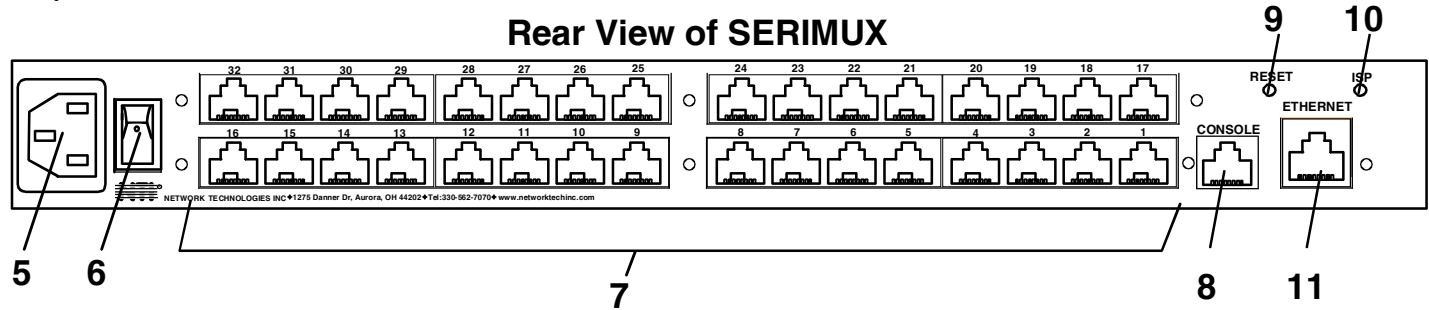

## FEATURES AND FUNCTIONS

1. **PWR LED**- LED will illuminate to indicate the SERIMUX is ON
2. **Port LEDs**- LEDs will illuminate to indicate active administrator port and data traffic; also used to indicate port or user number when entering commands from the keypad.
3. **Command LEDs**- LEDs will illuminate to indicate functions being performed
4. **Keypad**- for manual control of switch functions
5. **IEC Connector**- for connection of power cord
6. **Power Switch**- for turning the SERIMUX ON or OFF
7. **Port connectors**- RJ45 female serial connectors- for connecting serial cables from Terminals or CPUs
8. **Console Port**- RJ45 female serial connector- for connecting serial cable from a terminal console
9. **Reset button**- For power cycling the SERIMUX firmware without powering down the SERIMUX
10. **ISP button**- For use when restoring the firmware in the SERIMUX (**factory use only**)
11. **Ethernet (optional)**- RJ45 female connector- for connection of CAT5 cable to Local Area Network (LAN) for WEB interface

## INSTALLATION

This NTI switch was designed to be mounted to a rack or to set on a desktop. It includes rack mount ears to make attachment to a rack easy, and rubber feet to be applied to the bottom of the case if it will instead sit on a flat surface. If this will sit on a flat surface, simply apply the rubber feet to the bottom of the case in each of the 4 corners.

### To Mount to a Rack

1. Attach the ears to the switch using the #6-32x3/16" flat Phillips-head screws (6) provided as shown in the illustration below. The holes in the ears should line up with pre-threaded holes in the sides of the NTI switch. Tighten the screws securely.

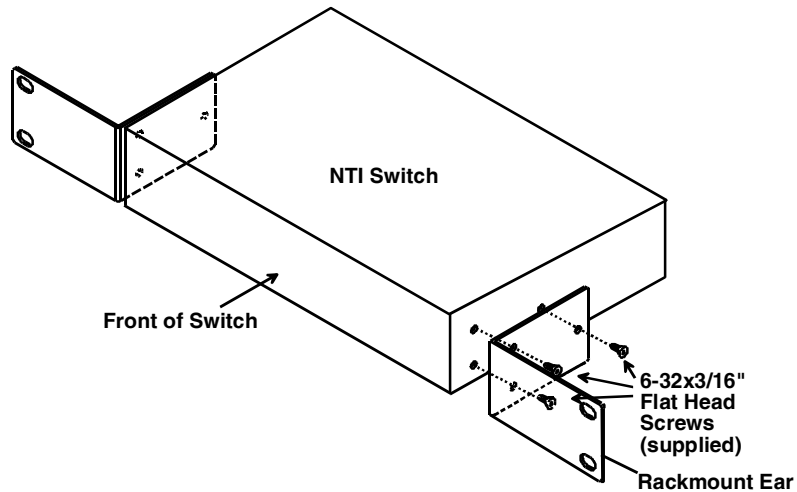

**Figure 1- Secure rackmount ears to switch**

2. Install 4 cage nuts (supplied) to the rack in locations that line up with the holes in the mounting ear on the NTI switch.
3. Secure the NTI switch to the rack using four #10-32X3/4" screws (supplied). Each screw should be of sufficient length to go completely through the NTI mounting ear, rack frame and fully engage all threads in the cage nut. Be sure to tighten all mounting screws securely.
4. Attach all cables securely to the switch and where necessary supply adequate means of strain relief for cables.

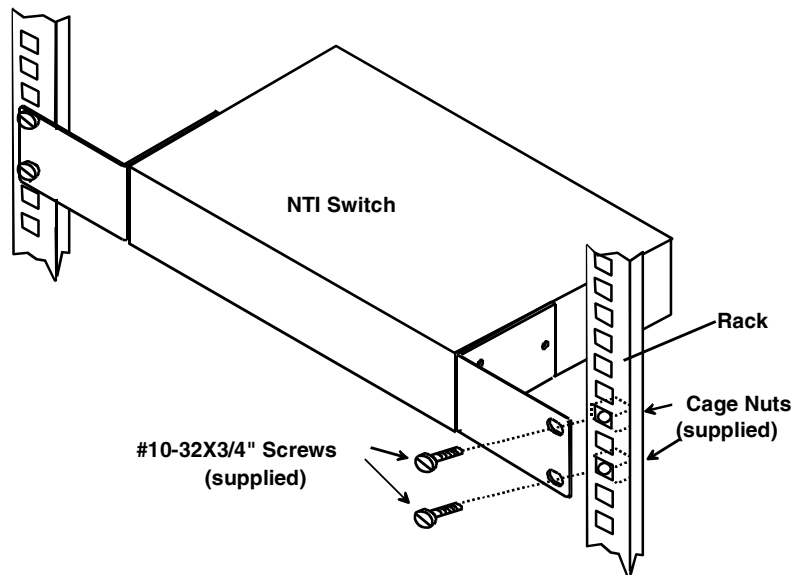

**Figure 2- Secure switch to a rack**

## Cable Connections

1. Connect a serial device to the port labeled "CONSOLE" on the SERIMUX using a serial cable with an RJ45 male connector (see cable specification on page 59). This will be the default administrator device. (Figure 3)
2. Connect each additional serial device or host to be connected by the SERIMUX to any remaining port (1-8/16/24/32) using a DTE or DCE type serial cable. The SERIMUX is a DCE type device so all ports are pinned-out accordingly. It may be necessary to add one of the cable adapters (supplied) detailed in Appendix C (page 61) between the device port on the serial device or host and the RJ45 connector. An NTI RJ45MF-RS232-CO serial crossover adapter has been provided for connection of one DCE type device. More adapters can be purchased separately.

**Note:** There are two types of serial devices, data communication equipment (DCE)(i.e. modem) and data terminal equipment (DTE) (i.e. CPU), each having different connector pin assignments. The cable adapters (see Appendix C on page 61) make the proper connections. If your device does not communicate with the SERIMUX when plugged directly in with a pin-to-pin straight thru type connection, try adding a RJ45MF-RS232-CO crossover adapter. If the device does not work with a crossover adapter, try using a cable wired straight through pin-to-pin.

3. Follow the "Initial Startup" instructions on page 8.

### Rear View of SERIMUX

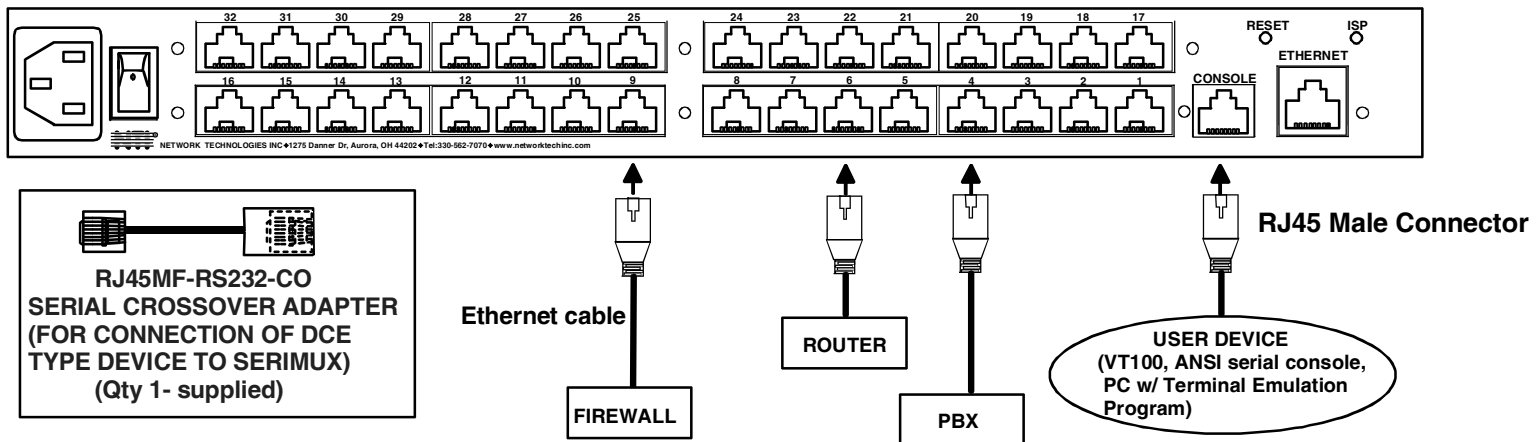

Figure 3- Connect terminals and devices to SERIMUX Console Switch

## Connect to the Ethernet

If the Ethernet option is present, the Web Interface (page 36) will be used. An Ethernet connection to the Local Area Network (LAN) must be made using Cat5 cable with RJ45 connectors attached. Wiring between connectors should be straight through (pin 1 to pin 1, pin 2 to pin 2, etc..) Connect a Cat5 cable between the connector labeled "ETHERNET" and the LAN (see Figure 4).

### Rear View of SERIMUX

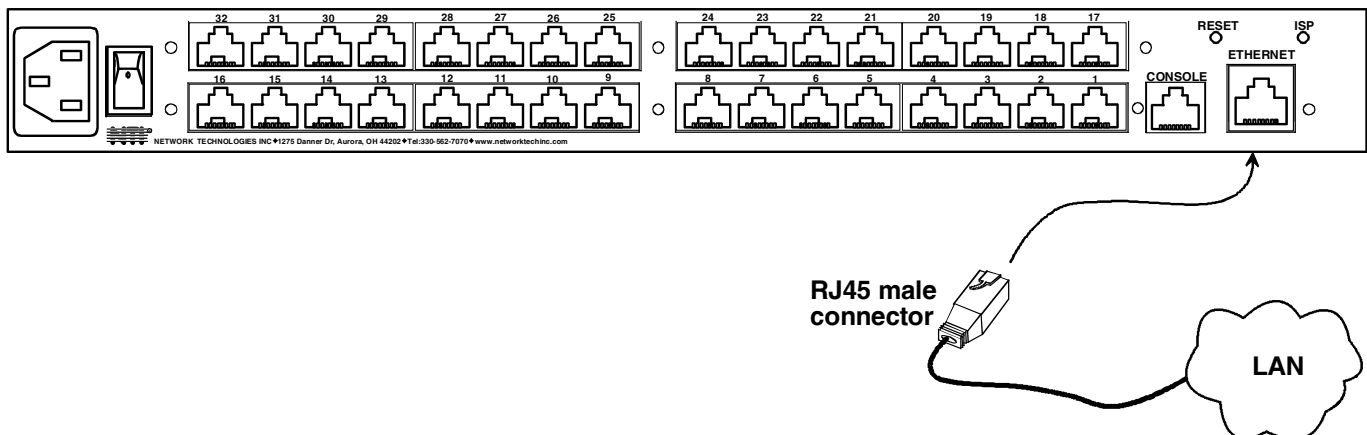

Figure 4- Connect the LAN to the SERIMUX

## Dual Power Option

The SERIMUX-CS-xDP has two IEC connectors on the rear, for connection to two separate power sources. If the power source connected to “PWR 1” fails, the ENVIROMUX will automatically and without interruption switch over to the power source connected to “PWR 2”.

**Note:** If only one power source is used, it should be connected to “PWR 1”.

**Note:** The power ON/OFF switch is located on the front panel of SERIMUX when two IEC connectors are present.

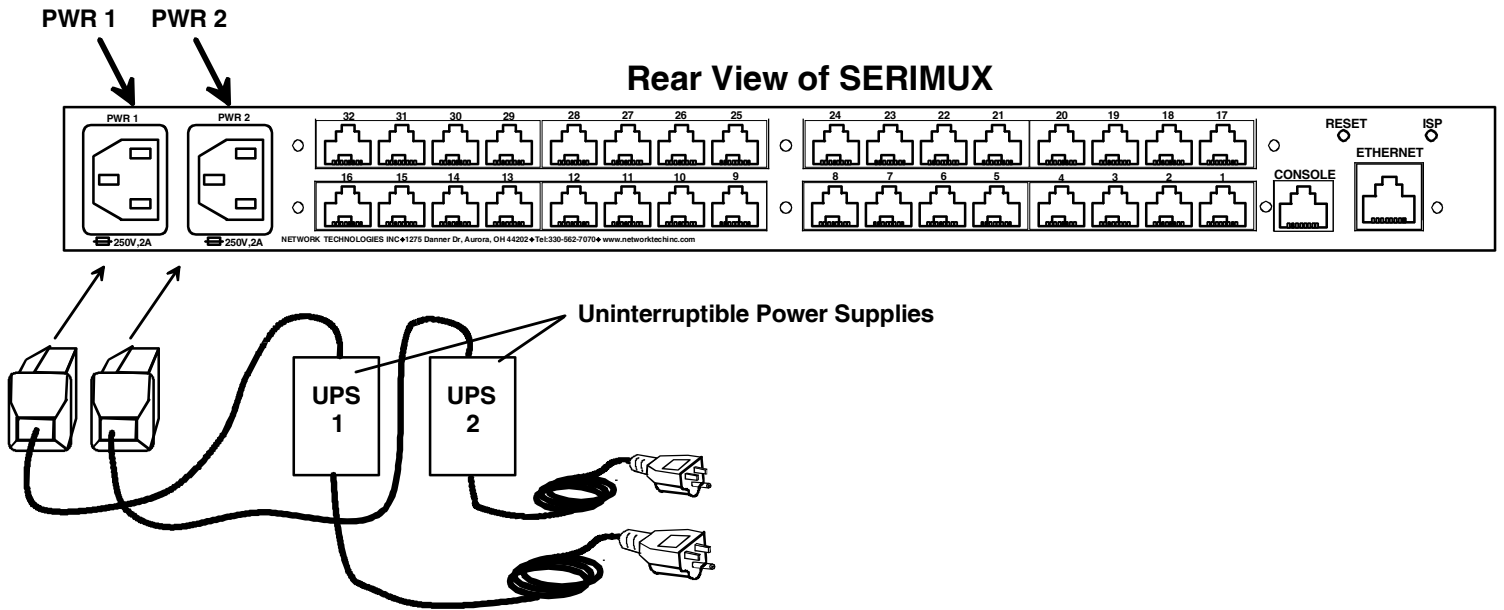

Figure 5- Power connections for SERIMUX with Dual Power option

## INITIAL STARTUP

### SERIMUX Quick Start

The following instruction will enable the user to quickly make port connections using a terminal connected to the "CONSOLE" port.

1. Make sure the SERIMUX is turned OFF.
2. Using the serial device connected to the port labeled "CONSOLE", start the terminal program (e.g. Windows HyperTerminal or Putty) and configure it as follows:
  - direct connection (using the appropriate CPU local serial Com port)
  - 9600 bps
  - 8 bits
  - no parity
  - 1 stop bit
  - no flow control
  - ANSI or VT100 terminal mode.

*Within the SERIMUX firmware, the "CONSOLE" port is identified as Port 0. For consistency, when Port 0 is mentioned within this manual, it refers to the terminal connected at "CONSOLE".*

3. Power ON the SERIMUX. Wait 2 seconds.
4. Press [ Enter ] on the keyboard and wait 3 seconds to be recognized as the default SERIMUX user. The "Accessible host list" for "User01", logged in at "Port00" will be displayed (see Figure 6). By default, all ports are configured as Host ports and all are accessible.

**NOTE: If the user menu does not display reset the SERIMUX following the "Reset SERIMUX Console Switch to default settings" instructions on page 35.**

5. To connect to an attached CPU, enter the number of the port the CPU is connected to and press [Enter].

```

serimux - HyperTerminal
File Edit View Call Transfer Help

Network Technologies Inc
Serial Console/Switch - v.1.14

User: 1; Name: User01
Port: 0; Name: Port00

Accessible host list:

 3.Port03      12.Port12      20.Port20      28.Port28
 4.Port04      13.Port13      21.Port21      29.Port29
 5.Port05      14.Port14      22.Port22      30.Port30
 7.Port07      15.Port15      23.Port23      31.Port31
 8.Port08      16.Port16      24.Port24      32.Port32
 9.Port09      17.Port17      25.Port25
10.Port10      18.Port18      26.Port26
11.Port11      19.Port19      27.Port27

Enter host port index to connect to host,
press [Enter] for user menu, [Esc] to logout_

Connected 0:24:49  Auto detect  9600 8-N-1  SCROLL  CAPS  NUM  Capture  Print echo

```

Figure 6- Startup- Accessible host list

## USING THE SERIMUX CONSOLE SWITCH

The SERIMUX Console Switch is controlled using

- Serial Control- from a "dumb" terminal- locally-connected  
- through an external modem from a remote location
- Keypad Control (reduced set of commands)
- Web Interface- from optional Ethernet connection to a LAN
- Command Line Interface- from optional Ethernet connection to a LAN

### Serial Control

The SERIMUX Console Switch can be easily configured using serial communications from either a locally-connected "dumb" terminal or from a terminal remotely connected through a modem. Using a keyboard-controlled menu, the user can modify various parameters and options for each port. The administrator menu can be accessed by the administrator for full feature control, or the user menu, by any user, for more restricted control of port connections.

### Keypad Control

The keypad has direct control over basic SERIMUX functions. The keypad can be used to make changes to port connections regardless of any menu control taking place. Command LEDs on the front panel of the SERIMUX Console Switch indicate the status of the switch and what function is being performed. For more on Keypad Control, see page 32.

**Note: The keypad will only work after first entering the assigned PIN number. See page 32 for more info.**

**The default keypad PIN number is 9999 (or 4444 for SERIMUX-CS-4).**

### Web Interface

With an Ethernet connection to a LAN, the user can remotely control SERIMUX port configuration and connections. The administrator menu can be accessed by the administrator for full feature control, or the user menu, by any user, for more restricted control of port connections. For more on Web Interface control, see page 36.

### Command Line Interface

With an Ethernet connection to a LAN, the administrator can additionally remotely view and change the SERIMUX port configuration using HyperTerminal, Putty (or other Telnet client). CLI commands can be sent individually or in groups to quickly configure the SERIMUX. For more on CLI commands, see page 54.

## SERIAL CONTROL- ADMINISTRATOR

Using serial control, the SERIMUX supports 2 operator levels, administrator and user, each with separate password protection for security.

- The administrator logs in using an administrator password

**administrator name : administrator or root (all lowercase letters)**

**administrator password : nti (all lowercase letters)**

- Users login using a password set by the administrator

**FYI: Users may be granted administrative access rights by the administrator.**

The administrator and any user with administrative rights can:

- view / modify port parameters;
- view / modify user parameters and user access rights to ports;
- disconnect ports, logout users etc.

*The administrator name cannot be changed.*

*To change the administrator password, see page 21.*

## Login as the administrator

1. From the user terminal connected to port 0, open the terminal program (configured as described on page 8 under "SERIMUX Quick Start").
2. Press [Enter] on the keyboard, wait three (3) seconds, and the port will open to the "Accessible host list" for "User01", logged in at "Port00".
3. Press [Esc] to logout, and [Y] to confirm. A message will be displayed "Disconnecting user now"
4. Press [spacebar] or [Enter]. A prompt requesting a Username will appear.
5. Enter **administrator** or **root** (all lowercase letters) and press [Enter]. A prompt requesting a password will appear.
6. Enter **nti** (all lowercase letters) and press [Enter]. The Administrator main menu will appear for user ROOT on port 0.

**Note:** This will only enter the administrator mode if the administrator password has not yet been changed from "nti".  
**FYI:** If SERIMUX is not at initial power-ON, omit steps 2 and 3 above to login.

```

Network Technologies Inc
Serial Console/Switch - v.1.14

User: root
Port: 0; Name: Port00

Administrator main menu

1.Port list
2.Port settings
3.Port disconnect
4.Port Connect
5.User list
6.User settings
7.User disconnect/logout
8.Advanced settings
A.Reboot
0.Logout
    
```

Figure 7- Administrator main menu

**FYI:** The Administrator main menu will also appear if a user with administrative privileges presses [4] from the User main menu.

From the Administrator main menu, the following options are possible:

Function	Description	Keystroke
Port List	Display the port list	[1]
Port settings	View or modify any port settings	[2]
Port disconnect	Disconnect any port and logout the user logged in or connected to the port	[3] + [port #]
Port Connect	Connect to any port . A connection can be made provided: <ul style="list-style-type: none"> <li>• the port is a host port (page 12)</li> <li>• the port has a serial device connected that is not currently in use</li> <li>• the user has access to the port (see page 45)</li> </ul>	[4] + [port #]
User list	Display the user list	[5]
User settings	View or modify user settings	[6]
User disconnect/logout	Disconnect and logout any user connected to a port	[7]
Advanced settings	View or modify advanced administrative settings (pg 21)	[8]
Return to user menu	Leave the administrative menu and return to the User main menu (only listed when a user with administrative rights is logged in)	[9]
Reboot	Reboot the SERIMUX	[A]
Logout	Logout from SERIMUX	[0]

## Port List

From the Administrator main menu, press [1] to display the Port List.

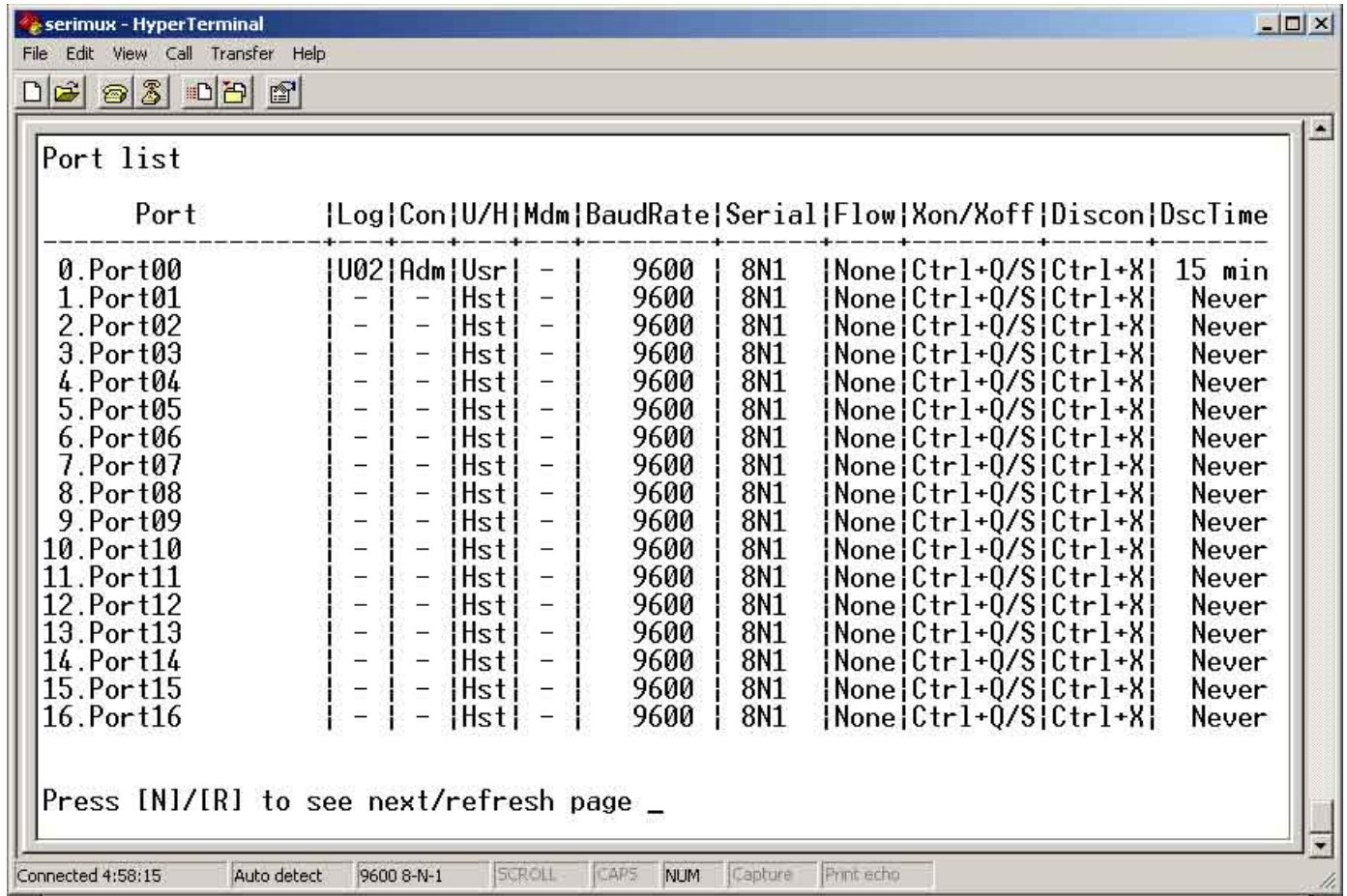

Figure 8- The Port list displays the status of all ports

The Port list displays the following information:

Column Heading	Description
Port	Port number and name
Log	Index number of the user logged in at the port
Con	The number of another port (Pxx) connected to that port . If the administrator is logged in, "Adm" will be displayed
U/H	Port type- User or Host
Mdm	Modem connection status: Y if modem is connected , - if not
BaudRate	Port transmitter and receiver speed
Serial	Character size, parity, and stop bit number
Flow	Flow control method- hard (RTS/CTS), soft (Xon/Xoff), both, or none
Xon/Xoff	Special characters used as soft flow control sequence
Discon	In-band disconnect sequence (1 character, 3 character, or none)
DscTime	Remaining time until self-disconnection due to port receiver inactivity (see below)



**FYI: RE: DscTime ( Disconnect Time)**

The value shown in the Port list is derived from various sources depending on the type of connection active at the time.

- If a user is logged into a port as just a user, the time shown will be the remaining time based on the user's timeout setting.
  - If a user is logged in with administrative privileges and performing administrative tasks, the time will be based on the administrator's timeout setting, not based on the user's timeout setting.
  - If two ports are connected to each other, and one port has a lower timeout setting than the other, the lower setting will be shown in the DscTime column and control the connection.
- Press [N] to display port information for ports greater than 16, and then [P] to see the previous page.
  - Press [R] to refresh the information displayed
  - Press [Esc] or [Spacebar] to return to the Administrator main menu

## Port Settings

From the Administrator main menu, press [2]-[x]-[Enter] where x is the number of the port to display the port settings for.

```
Port settings
Port: 1; Name: Port01
    1.Port name: Port01
    2.Port type: Host
    3.In-band disconnect sequence: [Ctrl+X] (024)
    4.Connection timeout: Never
    5.Serial settings
    6.Modem settings
    7.View port data buffer
    8.VT100 displaying delay: Normal
    9.Clear port data buffer
    A.Port Authentication: Local
    B.Line Feed Suppress(Telnet): Enable
    0.Reset port settings to default

Press [<|/>] to change port, [+] to copy port settings
```

Figure 9- The Port settings menu

From the Port settings menu, the configuration of each port can be viewed and changed.

Setting	Description	Value
Port name	Change the port name	Max. 15 characters
Port type	Host or User	H or U
In-band disconnect sequence	Select characters to use for in-band disconnect sequence	1 + code for 1-character sequence (see table below) 3 + desired characters for 3-character sequence 0- for no disconnect sequence T- display Control code list
Connection Timeout	Time left before connection will be broken due to receiver inactivity	0-90 minutes. If 0 is selected, the connection will never timeout.
Serial settings	Display serial settings menu	N/a
Modem settings	Display modem settings menu	N/a
View port data buffer	View the last 508 characters received and transmitted to/from the port	N/a
VT100 displaying delay	Modify the displaying extra delay	0 = None, 1 = normal, 2 = double, or 3 = triple  "None" value can be used if the display is faster (i.e. with a terminal emulator, like HyperTerminal, running on a PC); the other values are useful if real terminals or slower serial devices are used as user/administrator consoles.
Clear port data buffer	Clear the data buffer for the selected port	N/a
Port Authentication	Define if user authentication is required to access a port via Telnet	Local or None Local = username and password required None= no username or password is required
Line Feed Suppress(Telnet)	Enable or Disable Linefeed Suppression during Telnet session	0 = Disable 1 = Enable (Default)
Reset Port settings to default	Restores factory default port settings	A confirmation "Y" will be required

When [3] is pressed to change the in-band disconnect sequence, the choices provided are 0, 1, 3, or T. Pressing a [T] will bring up a Control code list containing key sequences used for 1-character sequences, and the ASCII codes associated with each. (See Fig. 8) To set a 1-character sequence, press [1], then the code from the table associated with the desired sequence.

**Note: If the 3-character disconnect sequence is enabled, the string: [CR][LF]<3-char sequence>[CR][LF] has to be received to break the connection (7 characters). The [CR] and [LF] ASCII characters stand for 13 and 10 decimal codes (ASCII Carriage Return and Line Feed) respectively.**

**FYI: If the 1-character sequence is selected, the connected device will not receive the disconnect character. If the 3-character sequence is selected, it will be sent to the connected device, prior to breaking the connection.**

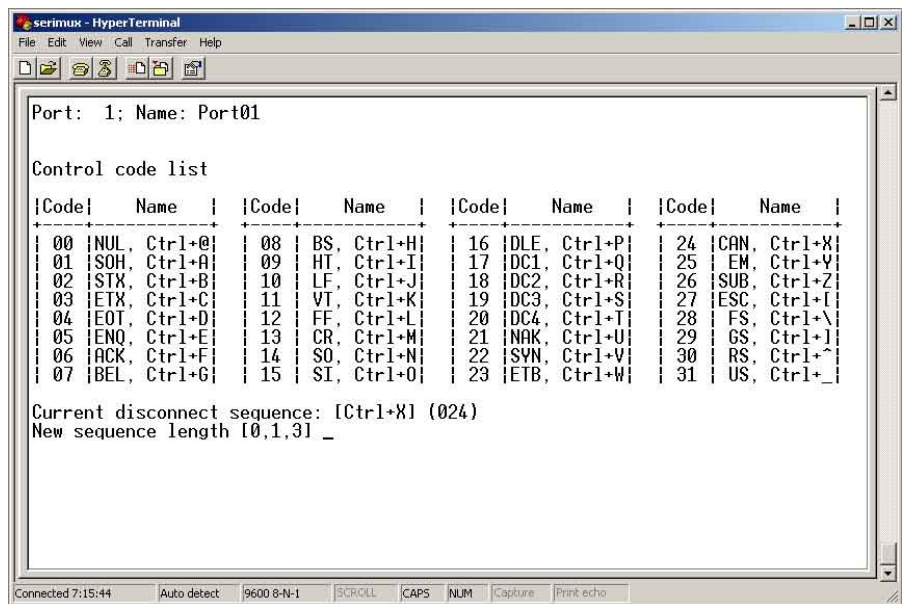

Figure 10- Control Codes for in-band disconnect sequence

- When selecting each new port setting values, press [Esc] or [Spacebar] to cancel, or press [Enter] to save.
- Press [>] (greater than symbol) to display the current settings for the next port.
- Press [<] (less than symbol) to display the current settings for the previous port
- Press [Esc] or [Spacebar] to return to the "Administrator main menu"

## Port serial settings

From the "Port settings" menu, press [5] to display the "Port serial settings" menu. Using this menu, the administrator can adjust the serial settings of each port, or copy the current port serial settings and paste them to another port or to all ports.

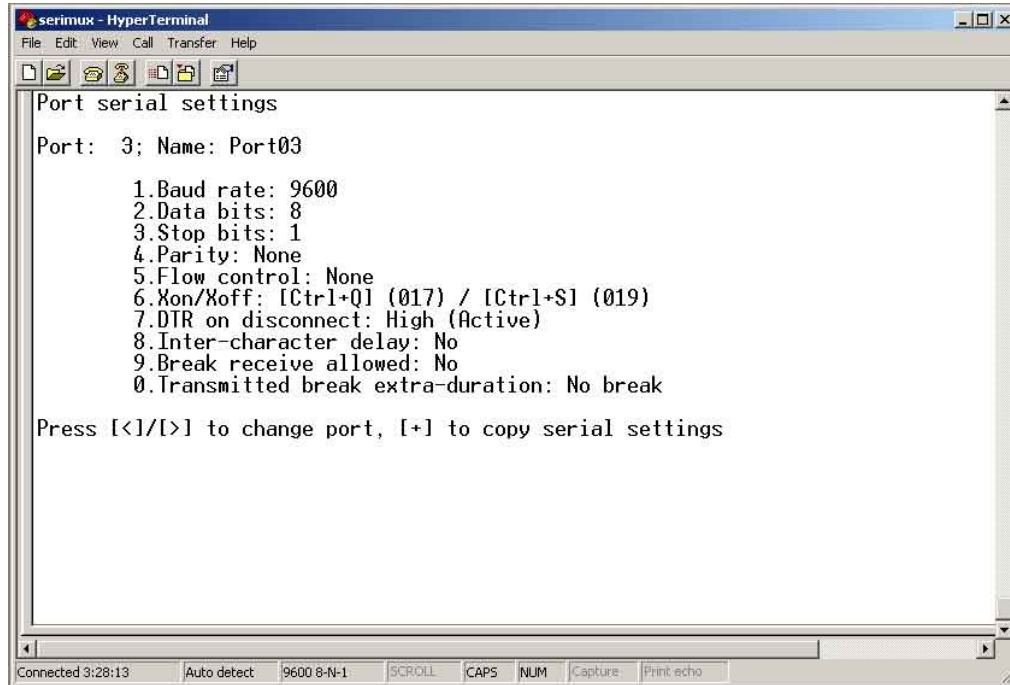

Figure 11- Port serial settings menu

### Baud rate

Any baud rate (serial speed) between 50 bps - 128Kbps can be selected, (except for port 0, between 300 bps - 115.2 Kbps). To modify the port serial speed (baud rate);

- press [1],
- enter the new value or press [T] for a table listing standard baud rates supported,
- and press [Enter]. A confirmation will be required for non-standard baud rate values.

### Data bit

The data bit number can be 5, 6, 7, 8, (except for port 0: 7 or 8).

To modify the data bit number;

- press [2],
- then the bit number: 5, 6, 7, 8

### Stop Bit

The stop bit number can be 1, 2, 1.5, (except for port 0: 1 or 2 stop bits).

To modify the stop bit number;

- press [3],
- then [1] or [2] or [A] to select 1, 2, or 1.5 stop bits respectively.

**Note: When Data bit is 5/6 the stop bit can be 1 or 1.5, otherwise it can be 1 or 2**

### Parity

Parity is set by pressing [4], then [N] for none, [E] for even, or [O] for odd.

### Flow Control

The flow control (hand shaking) can be hardware (RTS/CTS or out-band), software (Xon/Xoff or in-band), both or none.

To select the flow control;

- press [5],
- then [H] or [S] or [B] or [N] respectively.

**Note: If "N" for "none" is selected, data may be lost when sending large (greater than 1000 byte) data packets.**

**Note:** If a modem is attached to the port, and hardware and/or software flow control is used, the appropriate command may be added to the modem initialization string:

Flow control	Command 1	Command 2
None	-	-
RTS/CTS (hardware)	&K3	\Q3
Xon/Xoff (software)	&K4	\Q1
Both	&K6	
disable flow control (not necessary)	&K0	\Q0

Consult your modem user manual or the modem AT command manual to find the suitable command.

## Xon or Xoff Characters

Any non-printable character (ASCII codes between 0 and 31) can be used as flow control Xon or Xoff character. The software flow control is transparent, so the special character is not passed to the connected device. If the Xon and Xoff characters are equal, a toggle mode is automatically used in the software flow control: whenever the special flow control character is received, the current state of flow control is toggled.

To change the Xon or Xoff character;

- press [6],
- then [0] for Xoff or [1] for Xon,
- enter the new value,
- then press **[Enter]** to save it, **[Esc]** or **[Space]** to cancel.

**FYI:** Press [T] after [6] to display a control codes table.

## DTR line behavior

If a modem is not attached to the serial port, the DTR port line behavior on port disconnection can be selected as follows: the DTR line can be held high (active), low (inactive) or pulsed for 0.5 seconds and then held high. When a modem is attached to the port, the DTR line will be pulsed on port disconnection, disregarding this parameter value.

To modify the DTR line behavior on port disconnection;

- press [8],
- then **[H]** or **[L]** or **[P]** respectively.

## Inter-character delay

An inter-character delay (1 - 60 ms) may be defined, each time a character sequence is transmitted from the port. Using this command, a minimum pause will appear between transmitted characters; for example, certain types of electro-mechanical devices (like teletype equipment) cannot process received characters continuously at their specified baud rate.

To select an inter-character delay;

- press [8],
- enter the new value (0 for no delay),
- and press **[Enter]** to save it, **[Esc]** or **[Space]** to cancel.

**FYI:** This parameter is not available for port 0.

## Line-break receive or transmit

It is possible to accept the line-break received from a port, and to send it from the connected port. The break condition (when received) is defined as zero data with zero parity and no stop bits.

To allow or not the line-break receive;

- press [9],
- then **[Y]** for allowed,
- **[Esc]** or **[Space]** to cancel, any other character to deny.

To define the transmitted line-break extra-duration (this is added to the 1-character transmission time);

- press [0],
- then enter the new value (1 - 999 ms) or 0 to disable it,
- and press **[Enter]** to save it, **[Esc]** or **[Space]** to cancel.

**FYI:** These parameters are not available for port 0.

### Copy Port Serial Settings

- Press [+] to select the current port as source in a port settings copy-paste process (except port 0).
- Then, press [\*] to paste the port settings.
- Press [Y] to paste the selected port settings to the current port, [A] to paste to all ports, [s] to specify the destination port, or press any other key to cancel.

### Display serial settings for different port number

Press [>] (greater than symbol) to display the next higher port serial settings, or press [<] (less than symbol) to display the previous port serial settings.

Press [Esc] or [space] to return to the "Port settings" menu.

### Modem settings

From the "Port settings" menu, press [6] to display the "Modem settings" menu.

Remote connections are possible if modems are used, usually by the users. The remote modem may call in to a local modem attached to a SERIMUX port. A minimum number of port modem settings can be adjusted in the SERIMUX to control the connection (try the default values first; refer to the manual(s) for the modems otherwise).

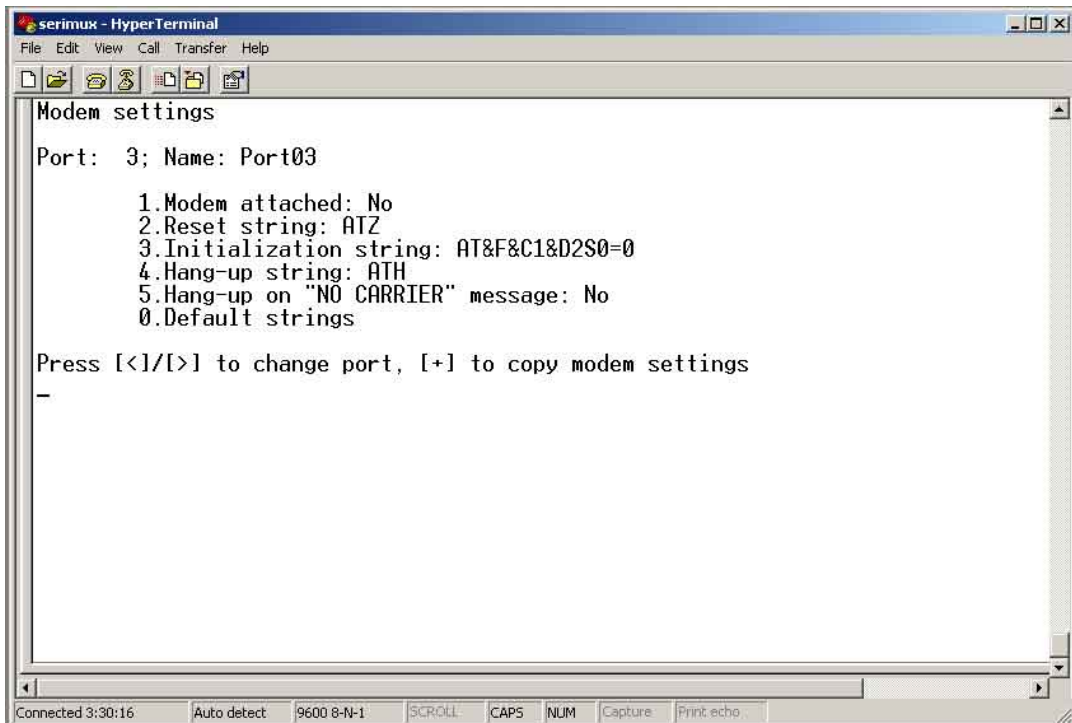

Figure 12- Modem settings menu

The administrator can initialize a modem attached to a SERIMUX port, or disconnect the modem. To control the modem connection from the "Modem settings" menu, the following functions are possible:

Function	Keystroke
Attach and initialize a modem	[1] - [A]
Disconnect a modem	[1] - [D]
Change the modem reset string	[2]
Change the initialization string	[3]
Change the hangup string	[4]
Enable hangup on "NO CARRIER"	[5]
Save the changes	[Enter]
Cancel the command	[Esc]
Reset to default values	[0]-[Y]

*FYI: If an old modem is attached to a SERIMUX port, it may be necessary to enable the "Hang-up on "NO CARRIER" message" option, in order to hang-up and disconnect the attached modem when receiving this message. Press [5], then [Y] to enable or any other key to disable this option. Usually, this option should remain disabled.*

- Press [ + ] to select the current port as source in a port modem settings copy-paste process (except port 0).
- Then, press [ \* ] to paste the port settings.
- Press [ x ] to paste the selected port settings to the current port, [ A ] to paste to all ports, [ s ] to specify the destination port, or press any other key to cancel.

**Display modem settings for different port number**

Press [ > ] (greater than symbol) to display the next port (next higher port index) modem settings, or press [ < ] (less than symbol) to display the previous port modem settings.

Press [ Esc ] or [ Space ] to return to the "Port settings " menu.

**Port data buffer**

From the "Port settings" menu, press [ 7 ] to view the port data buffer. In this display the administrator can see the last 508 characters received and transmitted to/from any port. This way the administrator can verify that data was transferred properly between ports.

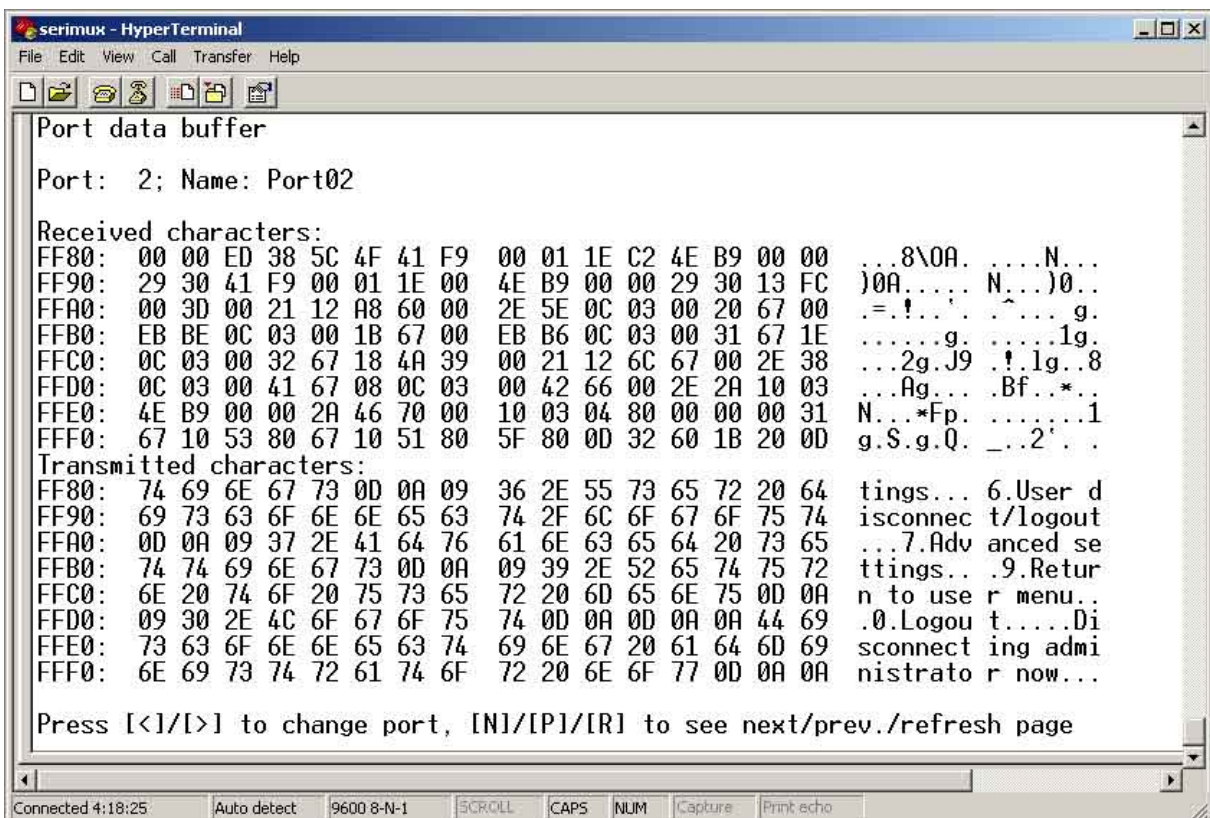

**Figure 13- Port data buffer**

Press [ P ] to see the previous (older) 128-character page information; press [ N ] to see the next (newer) 128-character page information.

Up to 508 received characters and 508 transmitted characters (4 pages) can be inspected, for each port.

Press [ > ] (greater than symbol) or [ < ] (less than symbol) to change the current port.

Press [ Esc ] or [ Space ] to return to the "Port settings " menu.

**FYI:** Only the "ROOT" administrator is able to access the port data buffer.

### Clear Port data buffer

From the "Port settings" menu, press [9] to clear the port data buffer. This selection will clear the entire buffer for data received by or transmitted from the respective port.

### User List

From the administrator main menu, press [5] to display the User list.

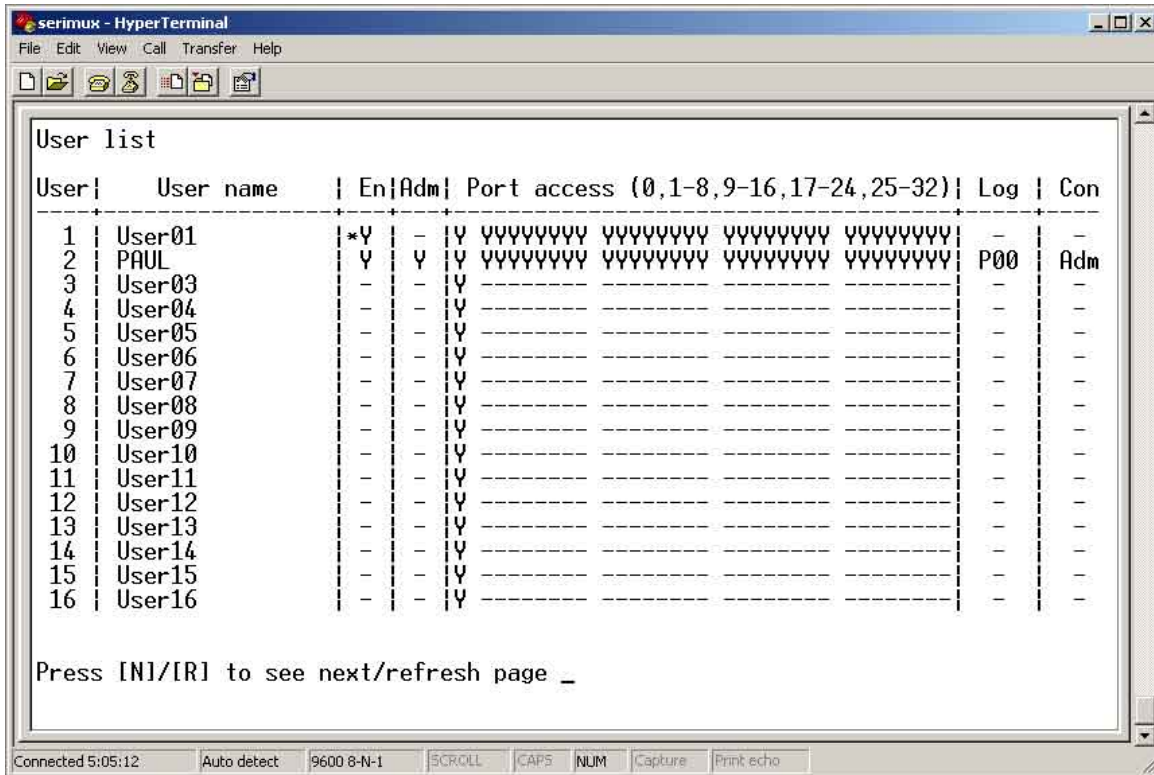

Figure 14- User List

Column Heading	Description
User	User Index number
User Name	User name associated with the index number
En	User status- "Y" = enabled " -" = not enabled
Adm	Displays if user has administrative rights "Y" = yes "-" = no
Port access	Displays what ports the user has access to
Log	Identifies what port the user is logged into, if any
Con	Identifies what port the user is connected to (Pxx) Or if the user is logged in as an administrator (Adm) Or if the user is just logged in (Usr)

- Press [R] to refresh the information and repaint the screen.
- Press [N] to see the next page; press [P] to see the first page.
- Press [Esc] or [space] to return to the "Administrator main menu".

## User Settings

From the "Administrator main menu", press [6], enter the user index number, then press [Enter]. The screen will show the current user number and name and the user settings menu:

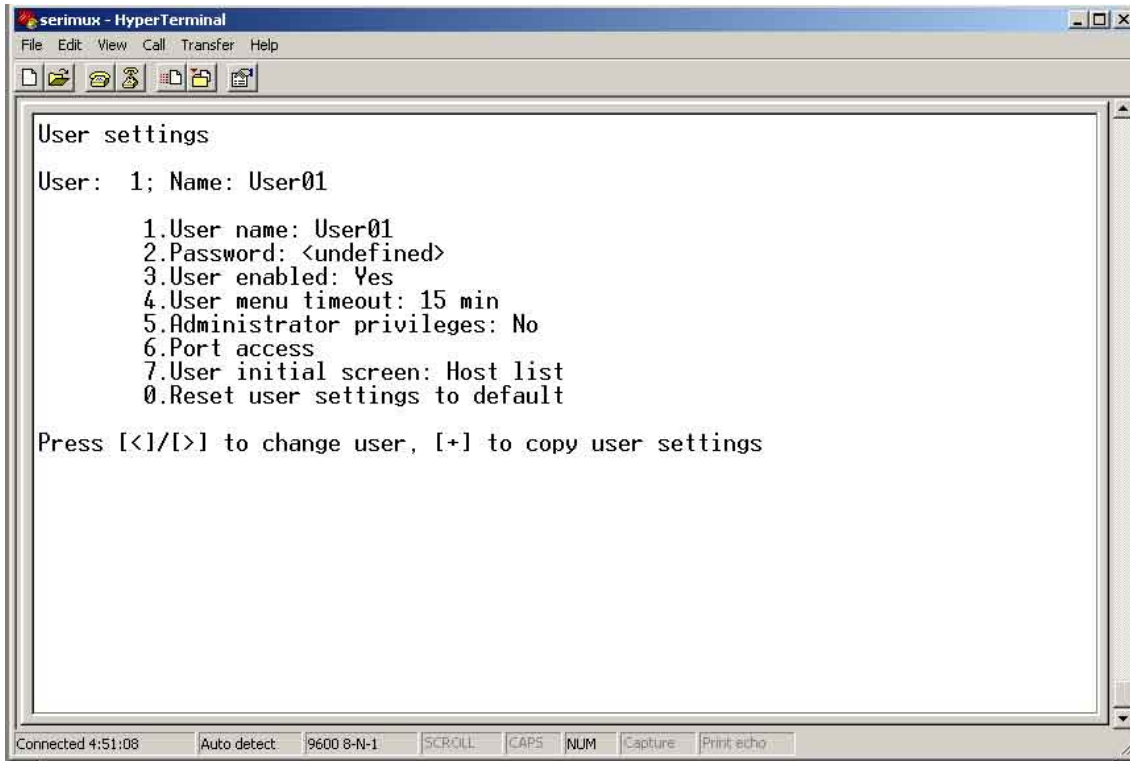

Figure 15- User settings menu

Setting	Description	Value
User name	Change the user name	Max. 15 characters, use backspace to delete
Password	Define the user password, if any	Max. 31 characters, use backspace to delete
User enabled	Enable or disable user	Y to enable, any other character to disable
User menu timeout	Time interval of user inactivity before auto logout of the user will occur	0-90 minutes 0 = never
Administrator privileges	Enable administrative privileges for user	Y to enable, any other character to disable
Port access	Define ports user has access to. Displays user's Port access list (Fig.14)	1 + port number to grant access to a port 0 + port number to deny access to a port < or > to change to different user access list
User initial screen	Select the initial user menu to display upon user login	M = User main menu H = Accessible host list T = Terse mode
Reset user settings to default	Restores factory default user settings	A confirmation "Y" will be required

- When selecting each new user setting values, press [Esc] or [Spacebar] to cancel, or press [Enter] to save.
- Press [>] to display the current settings for the next port.
- Press [<] to display the current settings for the previous port
- Press [Esc] or [spacebar] to return to the Administrator main menu



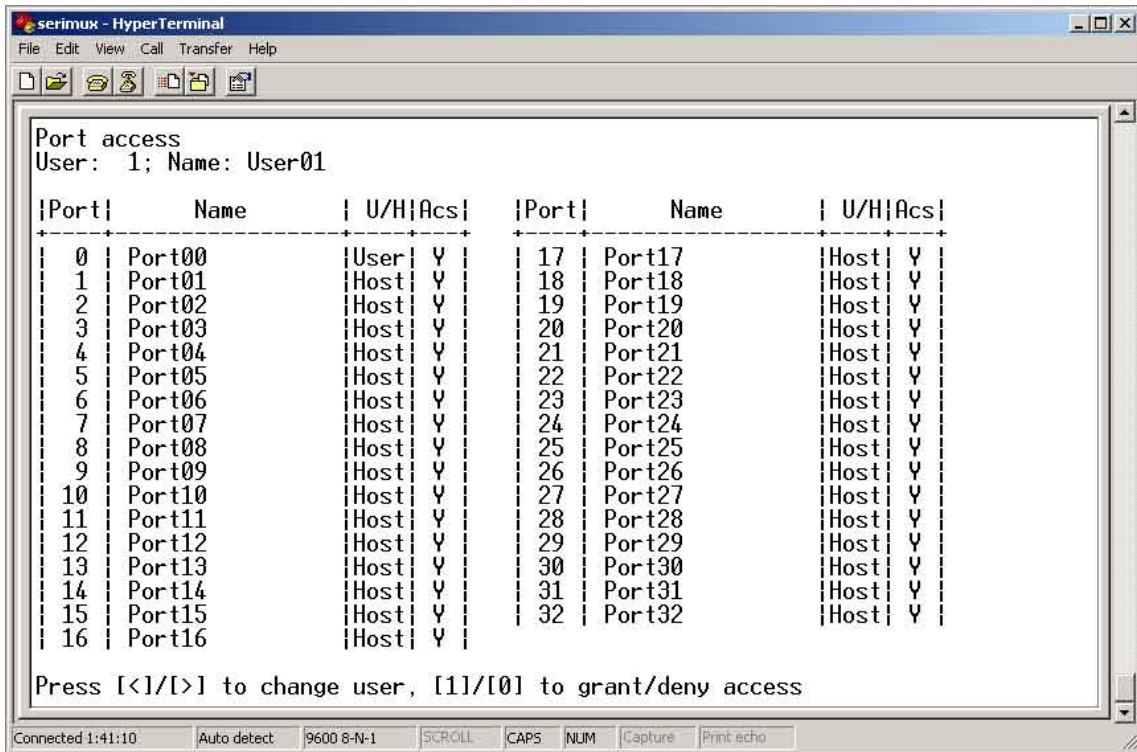

Figure 16- Port access list for User 01

**Port access**

To quickly grant/deny user access to multiple ports, the use of a dash (-) and/or comma may be used in conjunction with the [1] (to grant) or [0] (to deny) command.

i.e. [1] - [1-4,7,9,15] will grant access to ports 1 through 4, 7, 9, and 15, all in one command string

**Copy User Settings**

From the User settings menu,  
 press [+] to copy the current user's user settings to memory  
 press [\*] (asterisk) to start the paste function. Three options are available:

Option	Description
Y	apply the settings in memory to the current user shown
A	apply the user settings in memory to all users
Sxx	where xx is 01-16- apply the user settings in memory to a specific user

The "Y" option is particularly useful if the administrator wants to place a particular user's settings into memory and move around to other users (using the [<] or [>] keys) to review their settings before pasting the settings into memory over them.

The "S" option will allow the administrator to paste settings into memory to a specific user without having to view that user's settings list.

## Advanced Settings

From the "Administrator main menu", press [8] to display the "Advanced settings" menu.

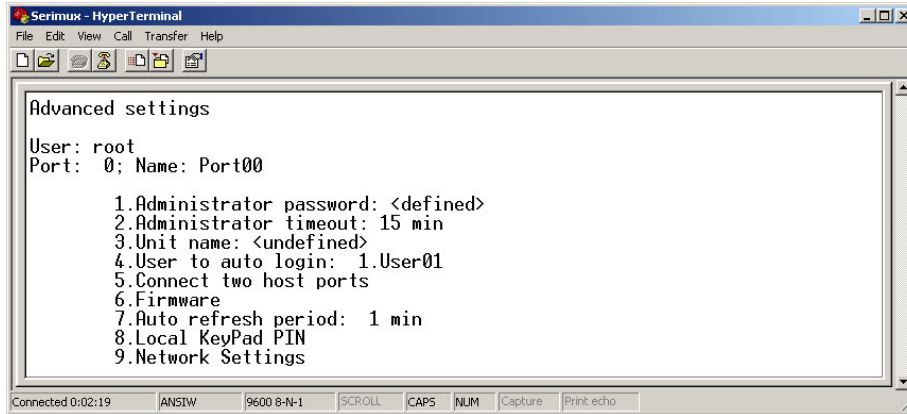

**Figure 17- Administrator's Advanced settings menu**

From the "Advanced settings" menu the administrator can perform the following functions:

Setting	Description	Value
Administrator Password	Define the password to be used by the administrator	Max. 31 characters. This can only be changed if old password is known. (If SERIMUX is re-initialized (pg 35), the default password ("NTI") will be restored)
Administrator Timeout	the time interval of administrator inactivity, prior to logging out.	0-90 minutes 0 = Never
Unit name	Name assigned to the SERIMUX	Max. 40 characters
User to auto login	User assigned to automatically login at power up without a password.	Index number of any enabled user that has access to the port being used for the user port
Connect two host ports	Connect two host ports together	Enter host port index number, press [Enter], second host port index number, and press [Enter] again
Firmware	Display the firmware menu	See pg. 22
Auto Refresh Period	Refreshes the admin screen after xx minutes	0-90
<b>Local KeyPad PIN</b>	<b>Defines the PIN number for Local keypad</b>	4 digit value 0000-9999 (default value is 9999 for most models, 4444 in SERIMUX-CS-4)
Network Settings	Define all network connection settings	See "Network Settings" - page 23

***FYI: If at power up the auto-login user does not have access to port being used, a login by a valid user with access rights will be required.***

### Change administrator password

For security purposes the administrator should change the factory default administrator password to a unique password. This will prevent unauthorized access to switch functions and CPUs. The password is needed to log in from any device, connected to any SERIMUX port in buffer mode.

To change the administrator password, from the Administrator main menu;

- press [7] to choose Advanced settings and press [Enter]. The Advanced settings menu will appear (Fig. 17)
- press [1] and a prompt for the old password will appear
- enter the old password (factory default password is "nti") and press [Enter]
- enter a new password (maximum 31 ASCII characters), using the [Backspace] key to erase any characters entered in error, and press [Enter]
- re-enter the password to confirm it, and press [Enter]
- a message "OK" will appear, press any key to return to the Advanced settings menu

***NOTE: The password entered will be case sensitive so be sure to note what characters are upper or lower case if any are alphabetical. The password characters are displayed as "\*" (asterisk) characters while entering them.***

***NOTE: If the administrator password is not known, the administrator must re-initialize the SERIMUX following the "Reset SERIMUX Console Switch to default settings" instructions on page 35.***

## Firmware

From the Advanced settings menu, press [6] to display the Firmware menu. (From Administrator main menu press [7]-[6])

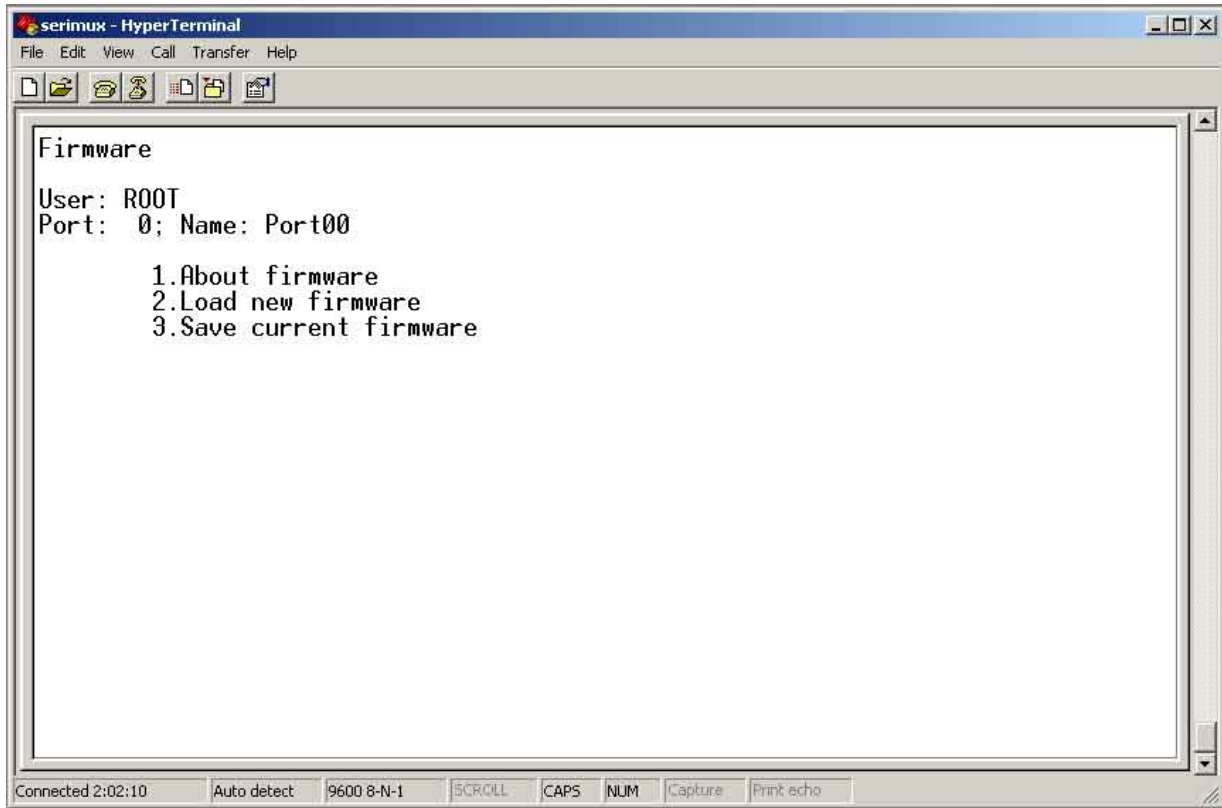

Figure 18- Firmware menu

The Firmware menu has three possible functions:

Function	Description
1. About Firmware	Provides information about SERIMUX including revision number, code length, and CRC
2. Load new firmware	Initiate firmware upgrade (see Firmware Upgrade- pg 30)
3. Save current firmware	Save present firmware in SERIMUX to binary file

### Load new firmware

To upgrade the firmware that controls the Console Switch, as soon as improved versions become available, download the firmware file (from the NTI website at [www.networktechinc.com](http://www.networktechinc.com)) to a local CPU, and follow the instructions under "Firmware Upgrade" on page 30 to install it.

**Note: Firmware upgrades can only be performed by an administrative user connected to Port 0 or Port 1.**

### Save current firmware

In order to save the firmware currently in SERIMUX, perhaps before installing new firmware, from the Firmware menu:

press [3] for Save current firmware. The message shown in Fig.19 will appear.

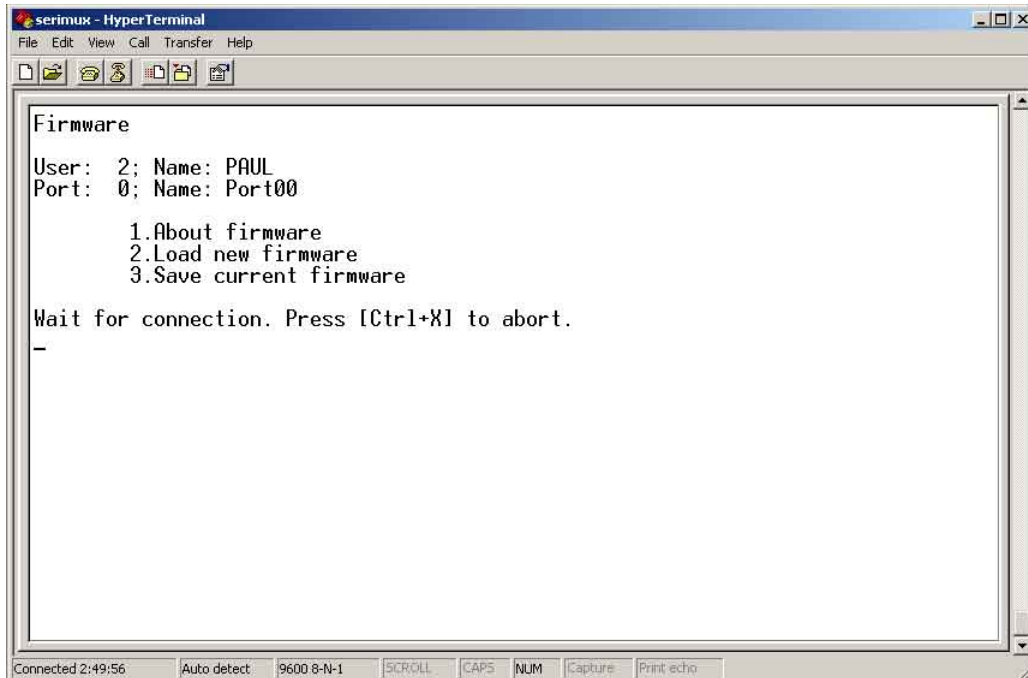

Figure 19- The SERIMUX is waiting to save its firmware

Using the terminal program, configured for Xmodem protocol, transfer the binary file from the SERIMUX to the user's CPU. (For example, in Windows HyperTerminal, use the **Transfer -> Receive File** command.) When saving the file, choose a directory to place the file in and a name that will identify it with the extension ".bin" (i.e. SERIMUX1\_8.bin). With the file saved, it can be restored from the CPU to the SERIMUX at any time if desired.

## Network Settings

From the Advanced settings menu, press [9] to display the Network Settings menu. (From Administrator main menu press [7]-[9])

To change a network setting;

- press the number associated with the item to change
- use the [Backspace] key to erase any characters to be changed, enter the new characters and press [Enter]
- press any key to update the Network Settings menu

Press [Esc] or [space] to return to the "Advanced Settings menu".

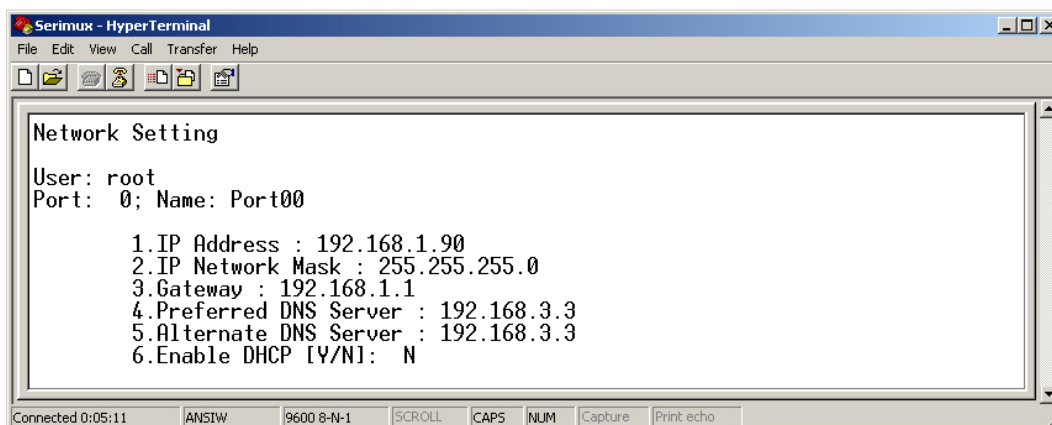
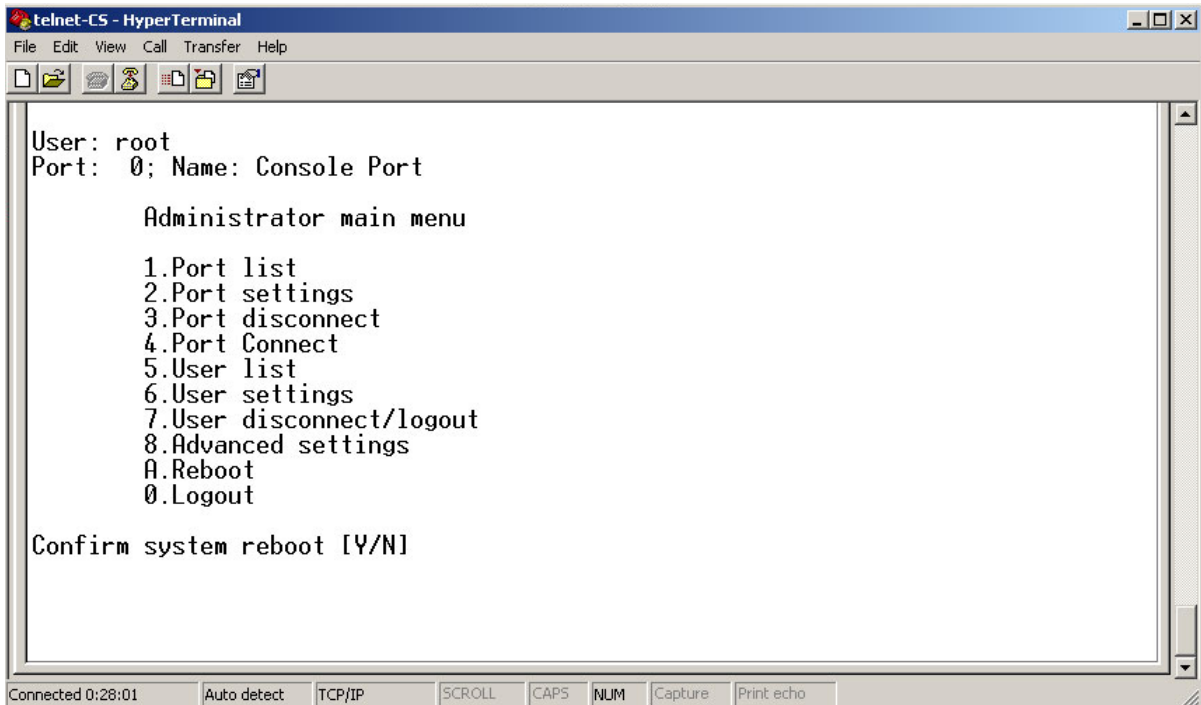

Figure 20- Network Settings menu

## Reboot

From the "Administrator main menu", press [A] to initiate a reboot of the SERIMUX. You will be prompted to confirm the command before a reboot will occur. After reboot, you will need to reconnect to the SERIMUX to resume operation.



```
telnet-CS - HyperTerminal
File Edit View Call Transfer Help
[Icons]
User: root
Port: 0; Name: Console Port

Administrator main menu

1.Port list
2.Port settings
3.Port disconnect
4.Port Connect
5.User list
6.User settings
7.User disconnect/logout
8.Advanced settings
A.Reboot
0.Logout

Confirm system reboot [Y/N]

Connected 0:28:01 Auto detect TCP/IP SCROLL CAPS NUM Capture Print echo
```

Figure 21- Reboot SERIMUX from console port connection

## SERIAL CONTROL-USERS

Users can connect only to accessible ports as defined by the administrator. A list of those ports will be displayed with a successful login.

To login, using a serial terminal or an emulator (e.g. Windows HyperTerminal),

1. connect the terminal to the SERIMUX at an allowed user port and press the [Spacebar] or [Enter] key.
2. type a valid user name (assigned by the administrator) and press [Enter].
3. type a valid password (assigned by the administrator) and press [Enter].

**Note:** User names and passwords are case sensitive. It is important to know what characters must be capitalized and what characters must not.

**FYI:** The administrator may select a user that will automatically login at power up (User 1 is setup by default). In this case, neither name nor password will be required, just press [Spacebar] or [Enter] after opening the terminal program.

After login, the user may connect to an allowed host port, or view host status and parameters. The user is unable to modify port parameters unless the user has been granted administrative privileges.

### User "Accessible host list" screen

After successful login, the "Accessible host list" will be displayed. The administrator may choose another initial screen to be displayed, following user's preferences. The Accessible host list includes:

- user index number and name
- index number and name of the login port
- index numbers and names of accessible hosts

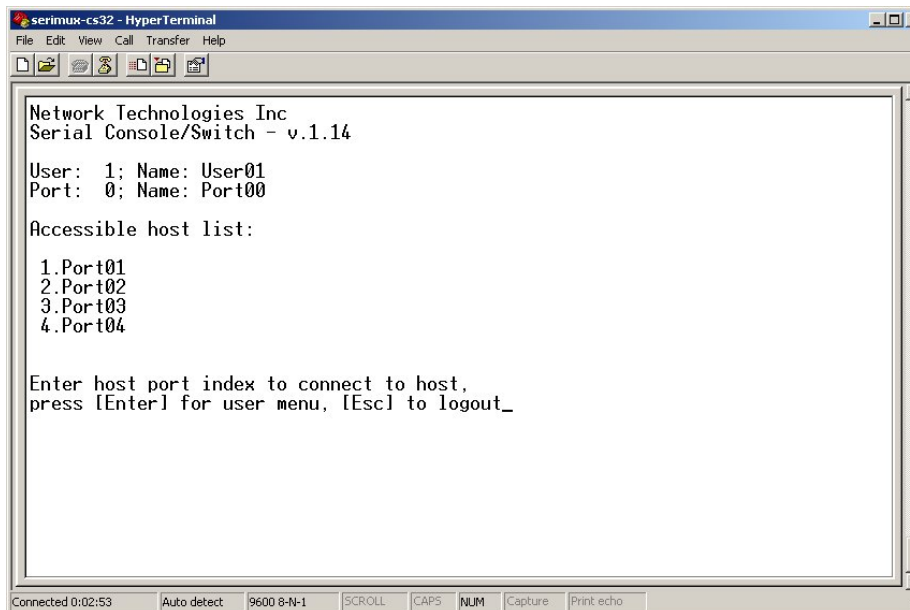

Figure 22- A user with limited host port access

From the "Accessible host list", the user can perform the following functions:

Function	Keystroke
Connect to host	[xx] - [Enter] (where xx is the port index number)
Refresh the screen	[Spacebar]
Logout	[Esc] or [Ctrl]+[X] , then [Y] to confirm

**FYI:** The port index numbers are 2-digit decimal numbers. If the wrong number is entered, simply enter the correct number. Only the last two numbers entered before the [Enter] key is pressed will be accepted. The [Enter] key validates the command; [Esc] or [Spacebar] cancels it.

## User main menu

The User main menu includes:

- user index number and name
- index number and name of the login port
- user command list

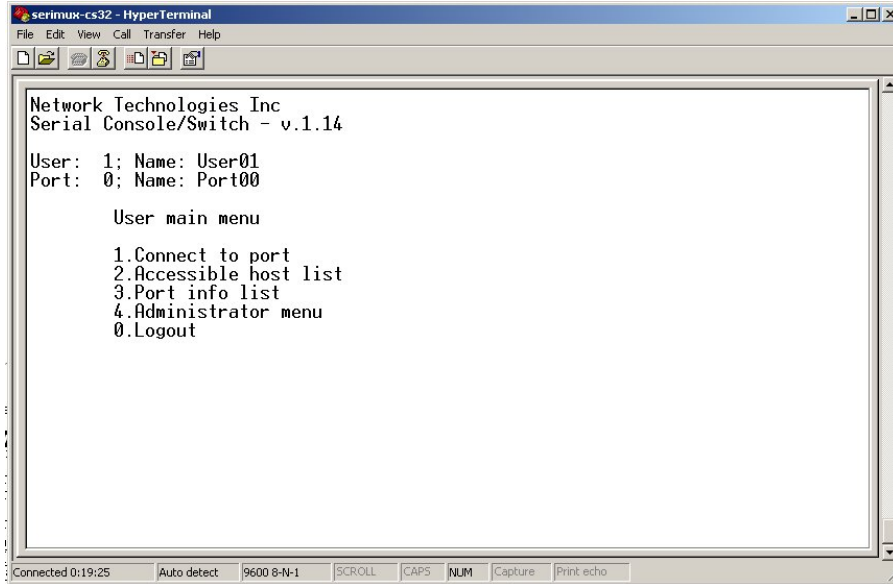

Figure 23- User main menu

From the "User main menu" the following functions are possible:

Function	Keystroke
Connect to host port	[1]-[xx]-[Enter] (where xx is the port index number)
Display Accessible host list	[2]-[Enter]
Display accessible host and user ports and info about each	[3]-[Enter]
Login as administrator	[4]-[Enter] (only works if user has administrative rights)
Logout	[0] then [Y] to confirm
Refresh the screen	[Spacebar]

A user can only connect to the hosts the user has been allowed access to by the administrator. Press [2] to display a list of accessible hosts.

## Port List screen

From the "User main menu", press [3] to display the list of user accessible ports and information about these ports. Only the administrator can change the communication settings.

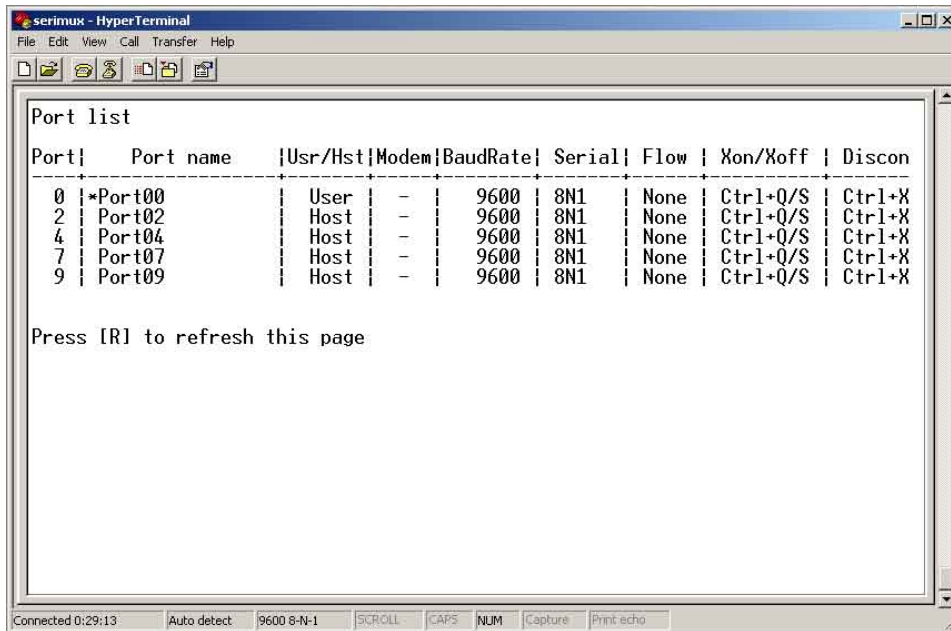

Figure 24- A limited user accessible Port list

On consecutive columns, the following are displayed:

Column	Description
Port	index number of the port
Port Name	Name assigned to the port
Usr/Hst	Port type, user or host
Modem	Yes if modem is attached, - if not
BaudRate	Receiving and transmitting speed of the port
Serial	Character size, parity, and stop bit number
Flow	Defines flow control method <ul style="list-style-type: none"> <li>• Hard (RTS/CTS or outband)</li> <li>• Soft (Xon/Xoff or inband)</li> <li>• Both</li> <li>• None</li> </ul>
Xon/Xoff	Characters used for Xon and Xoff flow control
Discon	In-band disconnect sequence (1-3 characters, or none)

Press [R] to refresh and re-display the information on the screen.

If the number of user accessible ports is greater than 17,  
 press [N] to see the next page,  
 press [P] to see the first page.

Press [Esc] or [space] to return to the "User main menu".



## User Terse mode

This mode is especially useful when the SERIMUX is directly controlled by external software from a serial console (as a user without administrative privileges), rather than being controlled by a user from a keyboard interface.

Entering short command strings performs functions similar to the user main menu commands. A [CR] – [LF] sequence ends every string. The commands are not echoed; the SERIMUX returns to the serial console a specific answer if the command is successfully accomplished or an error message otherwise.

Terse mode can be used only if the administrator configures a user port to enter into Terse mode at login (see page 19). If a keyboard-based user logs into a port intended for Terse mode operation, the following image will appear:

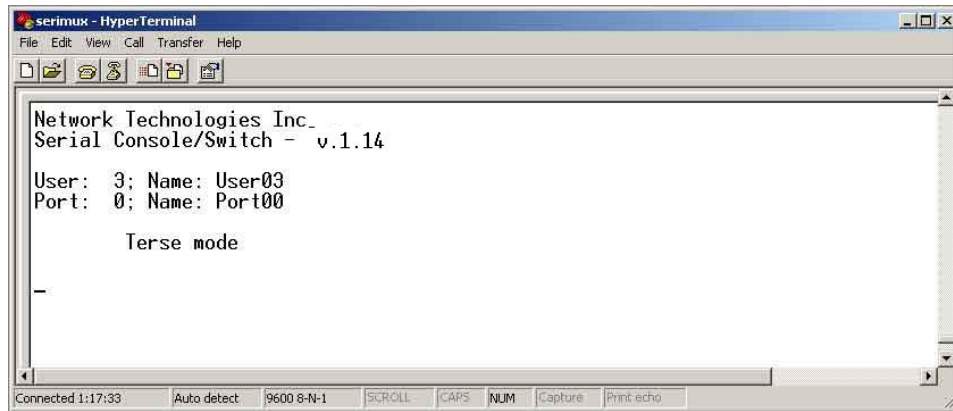

Figure 25- User port in Terse mode

From Terse mode, a limited number of functions are possible;

### Terse mode commands

#### > Connect to port

Send or type in:

[C] **xx** [Enter]

where **xx** is the port index number. The answer will be:

OK [CR][LF][LF][FF]

If an error occurs (i.e. the port is not accessible), the answer will be:

Err [CR][LF]

#### > Accessible host list

Send or type in:

[H] [Enter]

The answer may be, for example:

02,03,04,05,06,07,08,09,10,11,12,13,14,15,16 [CR][LF]

(the accessible hosts, separated by commas)

#### > Port info

Send or type in:

[P] **xx** [Enter]

where **xx** is the accessible port index number. The answer may be, for example:

04,H,9600,8N1,N,QS,1X [CR][LF]

where the comma separated fields stand for:

- port index number;
- port type: U or H for User or Host;
- port baud rate;
- data bits (5..7), parity (N, E, O for None, Even, Odd), stop bits (1, 1.5, 2,);
- flow control (N, H, S, B for None, Hard, Soft, Both respectively);
- in-band (soft) flow control Xon and Xoff characters (in this example Xon = [Ctrl+Q] and Xoff = [Ctrl+S]);
- disconnect sequence length and sequence (i.e. "0" for none, "1X" for 1-char [Ctrl+x] sequence, "3" for 3-char "" sequence);

If the port is not accessible to the user, the answer will be:

Err [CR][LF]

➤ **Verbose mode**

Send or type in:

[V] [Enter]

The answer will be:

OK [CR][LF]

and the Terse mode will be terminated. The “Accessible host list” or the “User main menu” will be displayed.

➤ **User Logout**

Send or type in:

[L] [Enter]

The answer will be:

OK [CR][LF]

With the next login of the same user, Terse mode will resume.

## Firmware Upgrade

It may be desired to upgrade the firmware that controls the SERIMUX as soon as improved versions become available. Once the firmware file has been downloaded from [www.networktechinc.com](http://www.networktechinc.com) to a local CPU, follow these instructions to install it.

1. Log-in as administrator, at ports 0 or 1 (port configured for 9600 bps, 8-bit, no parity, 1 stop bit).

**Note: During the transfer and the internal upgrade, all ports (except ports 0 and 1) and all users are disconnected.**

2. Locate on the local hard disk the binary file containing a valid firmware version (downloaded from the NTI website at [www.networktechinc.com](http://www.networktechinc.com)).
3. From the "Firmware" menu (pg 22) press [2], then [Y] to confirm. All other ports will be disconnected and disabled during the firmware update procedure.

**Note: When using Port 0 for firmware file transfer, if a different baud rate is desired for file transfer, change it in the terminal program now, before step 4. (Leave the baud rate at 9600 if Port 1 is used for the file transfer.) Remember, to re-establish communication with the SERIMUX after file transfer is complete, the terminal program baud rate must be reset to 9600.**

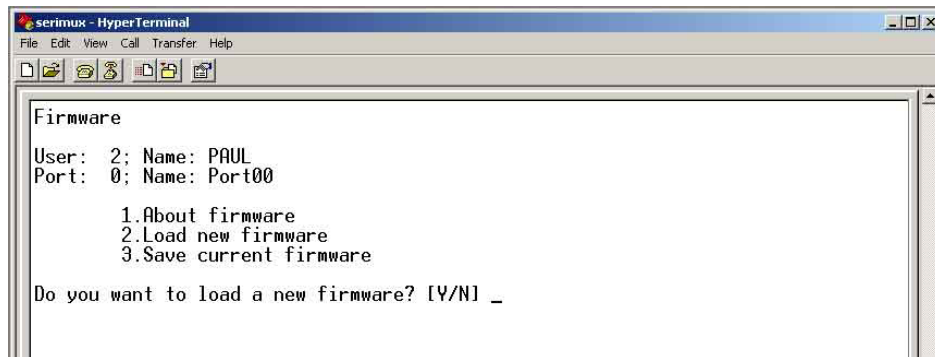

Figure 26- Firmware upload window

4. Type [A] + [T] "AT" (case sensitive, must be uppercase) to activate the SERIMUX auto baud detection.
5. When prompted, press [Y] to confirm, and [C] to continue with the procedure.

**Note: Proceeding past this point will erase all programming. The firmware upgrade must be completed for the SERIMUX to function.**

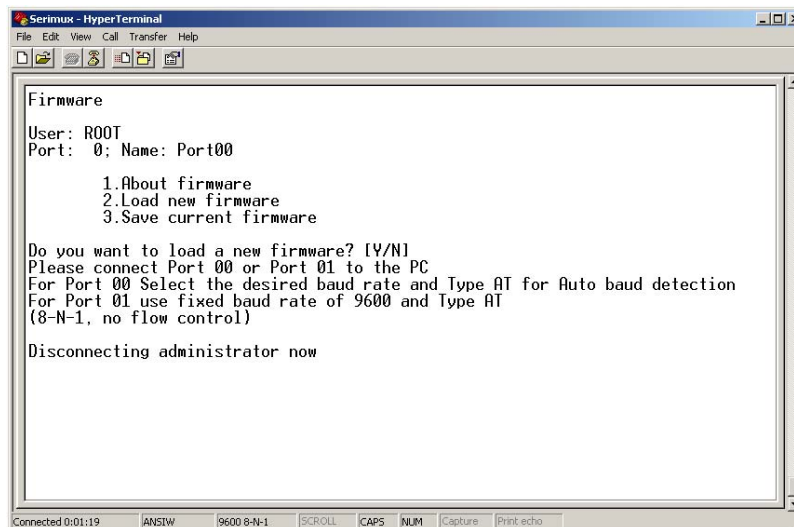

Figure 27- Type "AT" to auto-detect baud rate

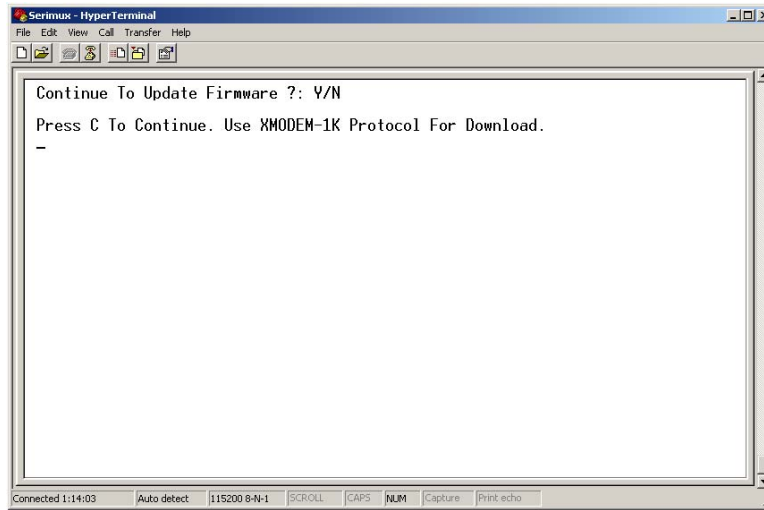

Figure 28- Last confirmation before firmware update

- Using the terminal program, send the binary firmware file using “1K Xmodem” protocol.

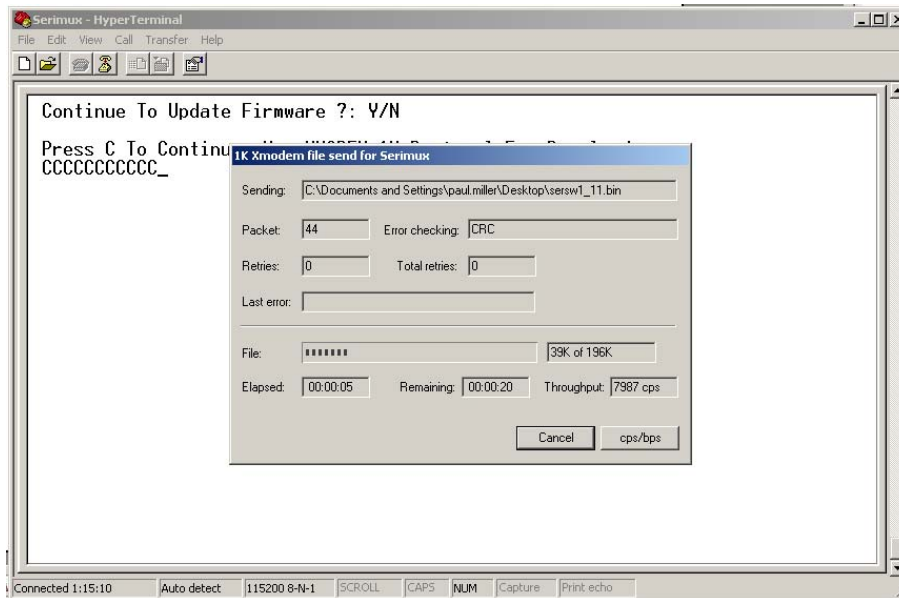

Figure 29- File transfer in progress

- After successful transmission the SERIMUX will automatically restart after few seconds. If not, power down the SERIMUX, power it back ON, and press [Enter].

**Note:** Be sure that the baud rate setting of the terminal program is the same as that last configured in the SERIMUX. If you cannot remember what the baud setting was, see “Reset SERIMUX Console Switch to default settings” on page 35.

If the firmware update failed or was interrupted for any reason, power cycle the SERIMUX and repeat the procedure beginning at step 4.

# KEYPAD CONTROL

Front View of SERIMUX

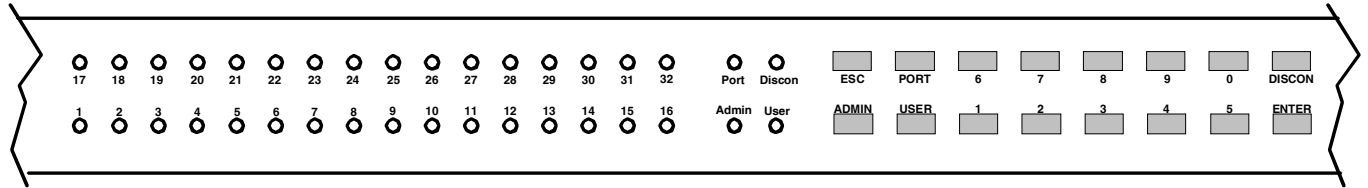

Figure 30- Keypad and LEDs

## Functions of the Keypad

During normal operation, the current administrator port number (if any) is displayed on the local front panel. The corresponding port LED will be continuously illuminated. The data traffic between connected ports is indicated the blinking of the corresponding port LEDs.

Using the keypad, anyone with physical access to the SERIMUX can:

- Login the administrator
- Logout the administrator
- Disconnect the administrator or a user with administrative privileges
- Login a user to the administrator main menu
- Login a user to a port
- Login a user and connect the user to a host port
- Disconnect and logout a user
- Connect 2 host ports
- Disconnect 2 ports
- Connect or disconnect a modem

**To enable the keypad**, the user must first press the “Enter” key on the keypad, enter the PIN on the keypad (default is 9999 in most models and 4444 in the SERIMUX-CS-4, see page 21) and press the “Enter” key again. The keypad is disabled again after 30 seconds of inactivity. If the keypad PIN is not entered, the keys will have no effect. If the PIN is successful, the Port, Discon, Admin, and User LEDs will all illuminate and remain illuminated for up to 30 seconds or until a command is entered.

**FYI: Buttons pressed in sequence on the keypad to enter commands must be pressed within 5 seconds of each other for the SERIMUX to respond. Otherwise, the sequence will need to be repeated from the beginning.**

## Login the administrator

**Note: In order to login the administrator to a port other than port 0, the administrator must first configure the desired port as a user port (see page 10). By default, all ports, other than 0, are configured as host ports.**

Action (from Keypad)	Reaction of SERIMUX
1. Press ADMIN	- The LED “Admin” will illuminate. The port 0 LED will be illuminated, the other port LEDs will be OFF.
2. Enter port number (00 by Default)	- The corresponding port LED will illuminate. The other port LEDs will be OFF.
3. Press ENTER	- If the command is successful the “Admin”, “Port”, “Discon”, “User” LEDs will illuminate together. They will turn OFF after 30 seconds or when any other key is pressed. - The administrator main menu (Figure 7, page 10) will be displayed on the terminal application running on the administrator port.

The “Administrator main menu” will be displayed on the serial device connected to the specified port if:

- the administrator was not already logged in at a different port;
- the specified port is not otherwise already connected and the port type is “User”.

**NOTE: If wrong digits are pressed when entering port numbers, enter the number for the correct port (01, 02, etc) before pressing ENTER. The Console Switch will acknowledge the last two digits pressed.**

## **Disconnect the administrator or a user with administrative privileges**

### **Action (from Keypad)**

1. Press DISCON
2. Press ADMIN
3. Press ENTER

### **Reaction of SERIMUX**

- The LED "Discon" will illuminate.
- The port 0 LED will be illuminated, the other port LEDs will be OFF.
- The LED "Admin" will illuminate.
- If command is successful the "Admin","Port","Discon","User" LEDs will illuminate together. They will turn OFF after 30 seconds or when any other key is pressed.
- The message: "Disconnecting administrator now" will be displayed by the terminal application running on the former administrator port.

## **Login a user to the administrator main menu**

### **Action (from Keypad)**

1. Press ADMIN
2. Press PORT
3. Enter port number (00 by default)
4. Press USER
5. Enter user number
6. Press ENTER

### **Reaction of SERIMUX**

- The LED "Admin" will illuminate. The port 0 LED will be illuminated, the other port LEDs will be OFF.
- The LED "Port" will illuminate.
- The corresponding port LED will illuminate, the other port LEDs will be OFF.
- The LED "User" will illuminate.
- The corresponding port LED will illuminate
- If the command is successful the "Admin","Port","Discon","User" LEDs will illuminate together. They will turn OFF after 30 seconds or when any other key is pressed.
- The administrator main menu (Fig. 7, page 10) will be displayed on the terminal application running on the administrator port.

The "Administrator main menu" will be displayed on the serial device connected to the specified port if:

- the administrator is not logged in;
- the specified user has administrative privileges, is enabled, and is not logged in;
- the specified port is accessible to the user;
- the specified port is not otherwise already connected and the port type is "User".

## **Login user to a port**

### **Action (from Keypad)**

1. Press USER
2. Enter the user number
3. Press PORT
4. Enter the port number
5. Press ENTER

### **Reaction of SERIMUX**

- The LED "User" will illuminate.
- The port 0 LED will be illuminated, the other port LEDs will be OFF.
- The corresponding port LED will illuminate
- The LED "Port" will illuminate
- The corresponding port LED will illuminate, the other port LEDs will be OFF.
- The User main menu will be displayed on the terminal application on the user port: (see Figure 23 on page 26 )
- If the command is successful the "Admin","Port","Discon","User" LEDs will illuminate together. They will turn OFF after 30 seconds or when any other key is pressed.

The initial user screen will be displayed on the serial device connected to the specified port if:

- the specified user is enabled, and is not logged in at another port;
- the specified port is accessible to the user;
- the port is not otherwise already connected and the port type is "User".

## **Login user to a port and connect the user port to a host port**

### **Action (from Keypad)**

1. Press USER
2. Enter the user number
3. Press PORT
4. Enter the user port number
5. Press PORT again
6. Enter the host port number
7. Press ENTER

### **Reaction of SERIMUX**

- The LED "User" will illuminate.
- The port 0 LED will be illuminated, the other port LEDs will be OFF.
- The corresponding port LED will illuminate
- The LED "Port" will illuminate
- The corresponding port LED will illuminate. The other port LEDs will be OFF.
- The LED "Port" will illuminate
- The corresponding port LED will illuminate. The other port LEDs will be OFF.
- The User main menu will be displayed on the terminal application on the user port: (see Figure 23 on page 26 )
- If command is successful the "Admin", "Port", "Discon", "User" LEDs will illuminate together. They will turn OFF after 30 seconds or when any other key is pressed.

The user will be connected if:

- the specified user is enabled, and is not logged in;
- the specified ports are accessible to the user;
- the user port is not otherwise already connected and the port type is "User".
- the host port is not otherwise already connected and the port type is "Host".

## **Disconnect and logout a user**

### **Action (from Keypad)**

1. Press DISCON
2. Press USER
3. Enter the user number
4. Press ENTER

### **Reaction of SERIMUX**

- The LED "Discon" will illuminate.
- The LED "User" will illuminate.
- The corresponding port LED will illuminate, the other port LEDs will be OFF
- The LEDs "Port", "Admin", "User", and "Discon" will illuminate briefly.

## **Connect 2 host ports**

### **Action (from Keypad)**

1. Press PORT
2. Enter the first port number
3. Press PORT again
4. Enter the second port number (to connect the first port number to)
5. Press ENTER

### **Reaction of SERIMUX**

- The LED "Port" will illuminate.
- The port 0 LED will be illuminated. The other port LEDs will be OFF.
- The corresponding port LED will illuminate, the other port LEDs will be OFF
- The LED "Port" will illuminate. The port 0 LED will be illuminated, the other port LEDs will be OFF.
- The corresponding port LED will illuminate. The other port LEDs will be OFF.
- If command is successful the "Admin", "Port", "Discon", "User" LEDs will illuminate together. They will turn OFF after 30 seconds or when any other key is pressed.

The two host ports will be connected if:

- the ports are not connected
- the ports type is "Host".

## Disconnect 2 ports

### **Action (from Keypad)**

1. Press DISCON
2. Press PORT
3. Enter the port number
4. Press ENTER

### **Reaction of SERIMUX**

- The LED "Discon" will illuminate.
- The port 0 LED will be illuminated, the other port LEDs will be OFF.
- 
- The corresponding port LED will illuminate, the other port LEDs will be OFF.
- If command is successful the "Admin","Port","Discon","User" LEDs will illuminate together. They will turn OFF after 30 seconds or when any other key is pressed.

The administrator can view any changes in port connections made from the keypad by opening the terminal program on any terminal connected to a user port and view the "Port list" (see page 8).

## Attach or detach a modem

### To attach a modem

#### **Action (from Keypad)**

1. Press DISCON
2. Press DISCON again
3. Press 1
4. Press PORT
5. Enter the port number
6. Press ENTER

#### **Reaction of SERIMUX**

- The LED "Discon" will illuminate.
- The port 0 LED will be illuminated, the other port LEDs will be OFF.
- The LED "Discon" will illuminate.
- The port 0 LED will be illuminated, the other port LEDs will be OFF.
- 
- The corresponding port LED will illuminate. The other port LEDs will be OFF.
- If command is successful the "Admin","Port","Discon","User" LEDs will illuminate together. They will turn OFF after 30 seconds or when any other key is pressed.

The modem will be initialized and connected if a modem is connected to the specified port and powered ON. The administrator can verify this by viewing the Port list (see page 8).

### To detach a modem

#### **Action (from Keypad)**

1. Press DISCON
2. Press DISCON again
3. Press 0
4. Press PORT
5. Enter the port number
6. Press ENTER

#### **Reaction of SERIMUX**

- The LED "Discon" will illuminate.
- The port 0 LED will be illuminated, the other port LEDs will be OFF.
- The LED "Discon" will illuminate.
- The port 0 LED will be illuminated, the other port LEDs will be OFF.
- 
- The corresponding port LED will illuminate. The other port LEDs will be OFF.
- If command is successful the "Admin","Port","Discon","User" LEDs will illuminate together. They will turn OFF after 30 seconds or when any other key is pressed.

## **Reset SERIMUX Console Switch to default settings**

SERIMUX can be reset to default settings by using the Keypad. This procedure is only necessary if the administrator is unable to access the administrator main menu. This should only occur if an administrator password has been set and the password is not known.

The SERIMUX should be OFF before beginning this procedure.

1. Press and hold both local keypad "ADMIN" and "ESC" buttons.
2. Turn ON the SERIMUX.
3. Wait 3 seconds.
4. Release the buttons.

**Caution: During the reset, the customer modified parameter values will be replaced with the factory default values (for default values, see page 31, Appendix A); user names and passwords will return to default values (pg. 9).**



## WEB INTERFACE

A user may control the connections of the SERIMUX using a Web Interface via any web browser (see page 2 for web supported browsers) provided the Ethernet option is present and connected. With the SERIMUX connected to a LAN through an Ethernet cable, a user can access the web interface controls inside the SERIMUX.

**FYI:** To quickly locate a SERIMUX on the LAN and edit the IP address settings, use the Device Discovery Tool (page 53).

To access the web interface, type the current IP address into the address bar of the web browser.

Address

To open a SSL-encrypted connection, type:

Address

You will be prompted to accept a certificate. Accept the NTI certificate.

A "Welcome Page" will appear.

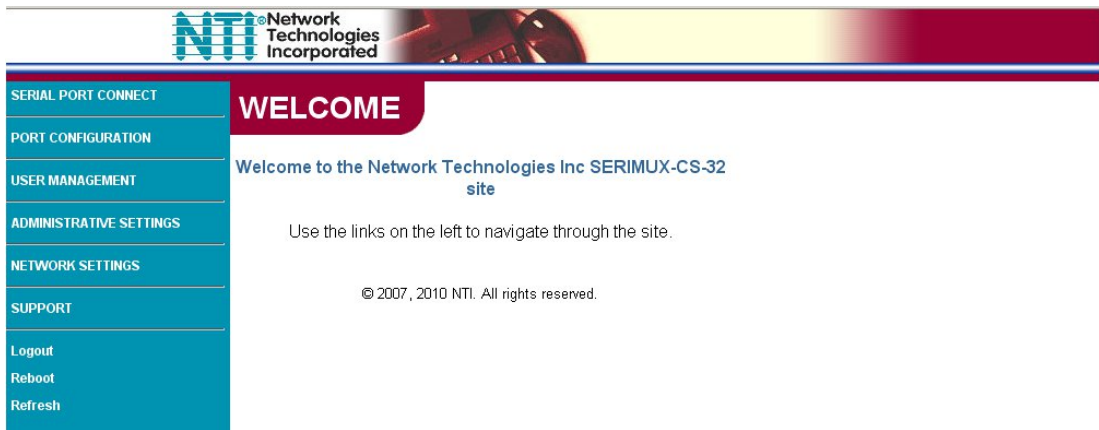

Figure 31- Web interface Welcome page

### Enter the Password

Select a link to the left to be prompted for a username and password. To change the password, see page 47.

**User Name = administrator or root** (lower case letters only)

**Password = nti** (lower case letters only)

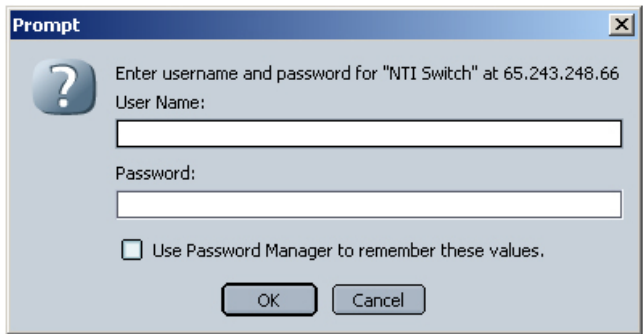

**Note:** The browser must be configured to accept cookies in order for the user to successfully make use of the web interface.

Figure 32- Web interface Login Prompt

As described on the following pages, each link will enable different areas of control for the SERIMUX.

## Port Configuration

### Port List Page

Port No.	Name	Baud Rate	Parameters	Flow Control	Connected	Timeout	User / Host	Disconnect	Xon / Xoff
0	Port00	115,200	8-1-None	None	Serial - User 2	Never	User	Ctrl+X	Ctrl+Q/S
1	Port01	9,600	8-1-None	None	No	Never	Host	Ctrl+X	Ctrl+Q/S
2	Port02	9,600	8-1-None	None	No	Never	Host	Ctrl+X	Ctrl+Q/S
3	Port03	9,600	8-1-None	None	No	Never	Host	Ctrl+X	Ctrl+Q/S
4	Port04	9,600	8-1-None	None	No	Never	Host	Ctrl+X	Ctrl+Q/S
5	Port05	9,600	8-1-None	None	No	Never	Host	Ctrl+X	Ctrl+Q/S
6	Port06	9,600	8-1-None	None	No	Never	Host	Ctrl+X	Ctrl+Q/S
7	Port07	9,600	8-1-None	None	No	Never	Host	Ctrl+X	Ctrl+Q/S
8	Port08	9,600	8-1-None	None	No	Never	Host	Ctrl+X	Ctrl+Q/S

Figure 33- Port List page

Under “PORT CONFIGURATION”, select “Port List” to display the Port List page. The Port List page displays the current configuration and status of each of the SERIMUX ports.

### Disconnect Port Page

Port No.	Name	Baud Rate	Parameters	Flow Control	Connected
0	Port00	115,200	8-1-None	None	No <input type="checkbox"/>
1	Port01	9,600	8-1-None	None	No <input type="checkbox"/>
2	Port02	9,600	8-1-None	None	No <input type="checkbox"/>
3	Port03	9,600	8-1-None	None	No <input type="checkbox"/>
4	Port04	9,600	8-1-None	None	No <input type="checkbox"/>
5	Port05	9,600	8-1-None	None	No <input type="checkbox"/>
6	Port06	9,600	8-1-None	None	No <input type="checkbox"/>
7	Port07	9,600	8-1-None	None	No <input type="checkbox"/>
8	Port08	9,600	8-1-None	None	No <input type="checkbox"/>

Disconnect

Figure 34- Disconnect Port page

Under “PORT CONFIGURATION”, select “Disconnect Port”. From this screen the administrator can disconnect any port connection desired. Place a check mark in the check box to the right of any connected port and press “Disconnect” at the bottom of the page. The associated port will be immediately disconnected and available for reconnection as needed.

**Connect Two Host Ports**

The screenshot shows the NTI Network Technologies web interface. The main heading is "PORT CONFIGURATION". Below this, there is a sub-heading "Connect Two Host Ports:". A table lists 8 ports with columns for Port No., Name, Baud Rate, Parameters, Flow Control, and Connected. Each row has a checkbox in the "Connected" column. At the bottom of the table area is a "Connect" button.

Port No.	Name	Baud Rate	Parameters	Flow Control	Connected
1	Port01	9,600	8-1-None	None	No <input type="checkbox"/>
2	Port02	9,600	8-1-None	None	No <input type="checkbox"/>
3	Port03	9,600	8-1-None	None	No <input type="checkbox"/>
4	Port04	9,600	8-1-None	None	No <input type="checkbox"/>
5	Port05	9,600	8-1-None	None	No <input type="checkbox"/>
6	Port06	9,600	8-1-None	None	No <input type="checkbox"/>
7	Port07	9,600	8-1-None	None	No <input type="checkbox"/>
8	Port08	9,600	8-1-None	None	No <input type="checkbox"/>

**Figure 35- Connect Two Host Ports page**

Under “PORT CONFIGURATION”, select “Connect Two Host Ports”. From this screen the administrator can select any two ports to be connected to each other. Place a check mark in check box to the right of any two ports and press “**Connect**” at the bottom of the page. The associated ports will be immediately connected.

**Clear Port Buffer**

**PORT CONFIGURATION**

Clear Port Buffers:

Port No.	Name	Baud Rate	Parameters	Flow Control	Connected
0	Port00	115,200	8-1-None	None	No <input type="checkbox"/>
1	Port01	9,600	8-1-None	None	No <input type="checkbox"/>
2	Port02	9,600	8-1-None	None	No <input type="checkbox"/>
3	Port03	9,600	8-1-None	None	No <input type="checkbox"/>
4	Port04	9,600	8-1-None	None	No <input type="checkbox"/>
5	Port05	9,600	8-1-None	None	No <input type="checkbox"/>
6	Port06	9,600	8-1-None	None	No <input type="checkbox"/>
7	Port07	9,600	8-1-None	None	No <input type="checkbox"/>
8	Port08	9,600	8-1-None	None	No <input type="checkbox"/>

Clear

Figure 36- Clear Port Buffers page

Under “PORT CONFIGURATION”, select “Clear Port Buffer”. From this screen the administrator can clear the entire data buffer for data received by or transmitted from the respective port. Place a check mark in the check box to the right of any port and press “Clear” at the bottom of the page. The data buffer for the respective port will be cleared of all data.

**Port Settings**

**PORT CONFIGURATION**

Port Settings:

Port Number	Port Name	Port Connected
0	Port00	No
1	Port01	No
2	Port02	No
3	Port03	No
4	Port04	No
5	Port05	No
6	Port06	No
7	Port07	No
8	Port08	No

Figure 37- Port Settings page

Under “PORT CONFIGURATION”, select “Port Settings” to display the Port Settings page. This page displays the number, name, and connection status of each port. As long as the connection status for a port is “No” (not connected), the settings can be changed. To proceed to the “Change Port Settings” page for any non-connected port, select the desired Port Name. The Change Port Settings page for the respective port will open.

Figure 38- Change Port Settings page

The Change Port Settings page provides boxes that can be edited with the settings associated with each port. The settings that can be changed include:

Setting	Description	Acceptable Value
Port Name	Define the name of the port	Max. 15 characters
Port Type	Define whether the port is a Host port or User port	Host or User (default is Host)
Disconnect Sequence	Select number of characters to use for in-band disconnect sequence	0 (disabled), 1, or 3 (the default is 1)
Select Disconnect Character	Character to use for in-band Disconnect sequence	Any ASCII nonprintable character ; 0-31 range (see drop-down list) (the default is Ctrl-X)
Disconnect Character	User defined characters to use when Disconnect sequence (above) is configured to be 3 characters	Any 3 ASCII characters
Connection Timeout	Time left before connection will be broken due to receiver inactivity	0-90 (minutes) If 0 is selected, the connection will never timeout.
Port Authentication Type	Define if a user will requires authentication to access a port via Telnet	Local or None Local = username and password required None= no username or password is required
Linefeed Suppress	Enable or Disable Linefeed Suppression during Telnet session	Enable or Disable Default value is Enable

Once the desired changes have been made, press the “**Apply**” button to save the settings. The changes will take effect immediately.

### Serial Settings

Serial Settings:		
Port Number	Port Name	Port Connected
0	Port00	Serial - User 2
1	Port01	No
2	Port02	No
3	Port03	No
4	Port04	No
5	Port05	No
6	Port06	No
7	Port07	No
8	Port08	No

Figure 39- Serial Settings page

Under “PORT CONFIGURATION”, select “Serial Settings”. This page displays the number, name, and connection status of each port. As long as the connection status for a port is “No” (not connected), the serial settings can be changed. To proceed to the “Change Serial Settings” page for any non-connected port, select the desired Port Name. The Change Serial Settings page for the respective port will open.

**PORT CONFIGURATION**

**Change Serial Settings:**

Port Number:

Port Name:

Baud Rate:

Data Bits:

Stop Bits:

Parity:

Flow Control:

Xon Character:

Xoff Character:

DTR Line Behavior:

Inter Character Delay:

Break Receive Allowed:

Break Transmission Duration:

Figure 40- Change Serial Settings page

The Change Serial Settings page provides boxes that can be edited with the serial communication characteristics associated with each port. The characteristics that can be changed include:

Setting	Value
Baud Rate	50bps-128Kbps (except port 0, between 300bps-115.2Kbps)
Data Bits	5, 6, 7, or 8 (except port 0, 7 or 8)
Stop bits	1, 2, or 1.5 (except port 0, 1 or 2 stop bits)
Parity	N (none), E (even), O (odd)
Flow Control	Hardware, Software, Both, or None
Xon Character	ASCII codes between 0 and 31 (see Fig. 9, pg. 13)
Xoff Character	ASCII codes between 0 and 31 (see Fig. 9, pg. 13)
DTR Line Behavior	High, Low, or Pulsed
Inter Character Delay	1-60 ms
Break Receive Allowed	Yes or No
Break Transmission Duration	1-999 ms or 0 to disable it

Once the desired changes have been made, press the “Apply” button to save the values. The changes will take effect immediately.

**Modem Settings**

Modem Settings:		
Port Number	Port Name	Port Connected
0	Port00	No
1	Port01	No
2	Port02	No
3	Port03	No
4	Port04	No
5	Port05	No
6	Port06	No
7	Port07	No
8	Port08	No

**Figure 41- Modem Settings page**

Under “PORT CONFIGURATION”, select “Modem Settings”. This page displays the number, name, and connection status of each port. As long as the connection status for a port is “No” (not connected), the modem settings can be changed. To proceed to the “Change Modem Settings” page for any non-connected port, select the desired Port Name. The Change Modem Settings page for the respective port will open.

**Figure 42- Change Modem Settings page**

The Change Modem Settings page provides boxes that can be edited with the modem communication characteristics associated with each port. Refer to your modem instructions for appropriate settings to be applied here.

The “HangUp on “NO CARRIER” “setting only applies to some older modems. Usually, this option will remain “No”.

Once the desired changes have been made, press the “**Apply**” button to save the values. The changes will take effect immediately.

To make connection with an attached modem, configure the fields as needed and press “**Attach**”.

To disconnect a modem in order to use the port for another device or user, press “**Detach**”.

**Copy Port Settings**

**NTI Network Technologies Incorporated**

**SERIAL PORT CONNECT**

**PORT CONFIGURATION**

**Copy Port Settings:**

Copy From Port: 1

Paste to Ports:

Port No.	Name	Baud Rate	Parameters	Flow Control	Connected
1	Port01	9,600	8-1-None	None	No <input type="checkbox"/>
2	Port02	9,600	8-1-None	None	No <input type="checkbox"/>
3	Port03	9,600	8-1-None	None	No <input type="checkbox"/>
4	Port04	9,600	8-1-None	None	No <input type="checkbox"/>
5	Port05	9,600	8-1-None	None	No <input type="checkbox"/>
6	Port06	9,600	8-1-None	None	No <input type="checkbox"/>
7	Port07	9,600	8-1-None	None	No <input type="checkbox"/>
8	Port08	9,600	8-1-None	None	No <input type="checkbox"/>

Paste

**Figure 43- Copy Port Settings page**

Under “PORT CONFIGURATION”, select “Copy Port Settings”. This page displays ports settings of each port on the SERIMUX, and the connection status of each. From this page the administrator can easily copy the port settings of a port to as many other ports as desired. This enables the administrator to save time when configuring the SERIMUX. As long as the connection status of the port to copy and the port(s) to be pasted to is “No” (not connected), the port settings can be copied to another port.

To copy settings,

1. select a port number whose connection status is “No” in the “Copy From Port” box.
2. Place a check mark in the box to the right of each port the settings should be copied to.
3. Press “**Paste**”. Settings will be immediately copied to the selected ports with immediate effect.



## User Management

### User List

USER MANAGEMENT					
User List:					
User No.	User Name	User Enabled	User Logged	Timeout	
1	User01	Yes	No	Never	
2	Larry	Yes	No	Never	
3	User03	No	No	Never	
4	User04	No	No	Never	
5	User05	No	No	Never	
6	User06	No	No	Never	
7	User07	No	No	Never	
8	User08	No	No	Never	
9	User09	No	No	Never	
10	User10	No	No	Never	
11	User11	No	No	Never	
12	User12	No	No	Never	
13	User13	No	No	Never	
14	User14	No	No	Never	
15	User15	No	No	Never	
16	User16	No	No	Never	

Figure 44- User List page

Under “USER MANAGEMENT”, select “User List”. The User List displays each of the user numbers, user names and their current status. The administrator can see who is enabled, logged-in, and the timeout setting for each.

### Disconnect User

USER MANAGEMENT					
User Disconnect:					
User No.	User Name	User Enabled	User Logged		
1	User01	Yes	No	<input type="checkbox"/>	
2	Larry	Yes	No	<input type="checkbox"/>	
3	User03	No	No	<input type="checkbox"/>	
4	User04	No	No	<input type="checkbox"/>	
5	User05	No	No	<input type="checkbox"/>	
6	User06	No	No	<input type="checkbox"/>	
7	User07	No	No	<input type="checkbox"/>	
8	User08	No	No	<input type="checkbox"/>	
9	User09	No	No	<input type="checkbox"/>	
10	User10	No	No	<input type="checkbox"/>	
11	User11	No	No	<input type="checkbox"/>	
12	User12	No	No	<input type="checkbox"/>	
13	User13	No	No	<input type="checkbox"/>	
14	User14	No	No	<input type="checkbox"/>	
15	User15	No	No	<input type="checkbox"/>	
16	User16	No	No	<input type="checkbox"/>	

Disconnect

Figure 45- User Disconnect page

Under “User Management”, select “Disconnect User”. the User Disconnect page Displays each of the user numbers, user names, and their current status. If any user is logged into a port, the administrator can place a checkmark in the box to the right of that user and press “Disconnect”, breaking their connection.

**User Settings**

USER MANAGEMENT				
User Settings:				
User No.	User Name	User Enabled	User Logged	
1	User01	Yes	No	
2	Larry	Yes	No	
3	User03	No	No	
4	User04	No	No	
5	User05	No	No	
6	User06	No	No	
7	User07	No	No	
8	User08	No	No	
9	User09	No	No	
10	User10	No	No	
11	User11	No	No	
12	User12	No	No	
13	User13	No	No	
14	User14	No	No	
15	User15	No	No	
16	User16	No	No	

Figure 46- Change User Settings page

Under “USER MANAGEMENT”, select “User Settings”. The User Settings list displays a list of each configured user and their connection status. As long as the log-in status for a user is “No” (not logged), the user settings for that user can be edited. To proceed to the “Change User Settings” page for any non-logged-in user, select the desired User Name. The Change User Settings page for the respective user will open.

## USER MANAGEMENT

Change User Settings:

User Number:	<input type="text" value="4"/>
User Name:	<input type="text" value="User04"/>
User Password:	<input type="password"/>
Confirm Password:	<input type="password"/>
User Enable:	<input type="button" value="Disable"/>
Administrator Rights:	<input type="button" value="No"/>
User Timeout (0-Never):	<input type="text" value="15"/>
Command Line Initial User Menu:	<input type="button" value="Host List"/>

Select Access list:

Port No.	Port Name	Access
1	Port01	<input type="checkbox"/>
2	Port02	<input type="checkbox"/>
3	Port03	<input type="checkbox"/>
4	Port04	<input type="checkbox"/>
5	Port05	<input type="checkbox"/>
6	Port06	<input type="checkbox"/>
7	Port07	<input type="checkbox"/>
8	Port08	<input type="checkbox"/>

Figure 47- Change User Settings page

From the Change User Settings page, the administrator can:

- configure how a user will be identified
- assign the user access password
- enable or disable a user's access to the SERIMUX
- apply administrative control rights to a user
- define the timeout period for automatic disconnection
- determine what initial screen a user will see when they log in
- specify what ports the user will have access to

Field	Value
User Name	Maximum 15 characters
User Password	Maximum 31 characters (no characters= no password)
Confirm Password	Retype user password- if any
User Enable	Enable or Disable
Administrator Rights	Yes or No
User Timeout	0-90 minutes (0= never)
Command Line Initial User menu	Main menu Host List Terse Mode

To specify what ports a user will have access to; place a check mark in the "Access" box for each applicable port.

### Copy User Settings

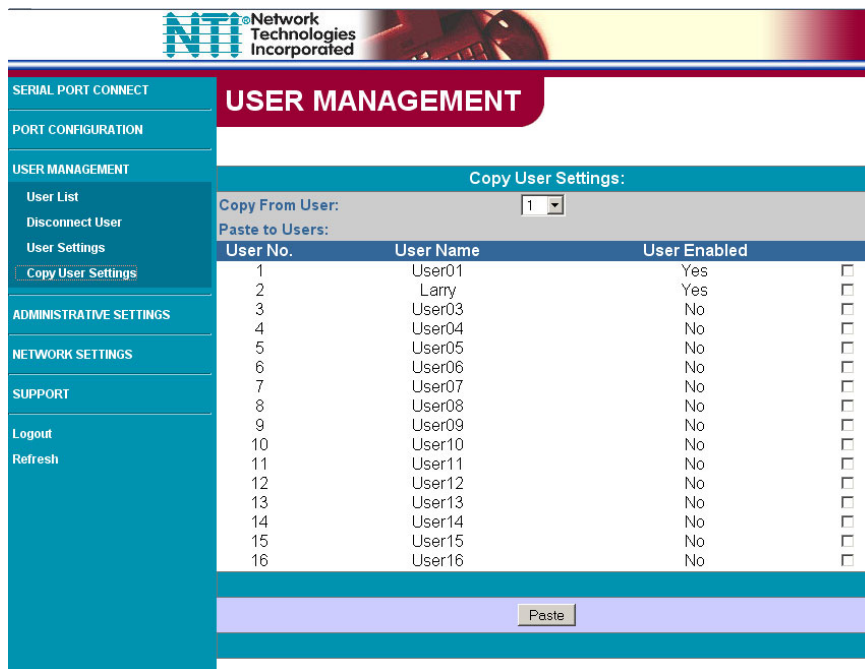

Figure 48- Copy User Settings page

Under "USER MANAGEMENT", select "Copy User Settings". This page displays the user name for each user defined in the SERIMUX, and whether their access is enabled or disabled. From this page the administrator can easily copy a user's configuration settings to as many other users as desired. This enables the administrator to save time when configuring the SERIMUX. As long as the access status of the user to be copied and the user(s) to have settings pasted to is "No" (not enabled), the user settings can be copied to another user.

To copy settings,

1. select a user number whose enabled status is "No" in the "Copy From User" box.
2. Place a check mark in the box to the right of each user the settings should be copied to.
3. Press "**Paste**". Settings will be immediately copied to the selected users with immediate effect.

## Administrative Settings

### Admin Config

The screenshot shows the NTI Network Technologies Incorporated logo at the top. Below it is a navigation menu with the following items: SERIAL PORT CONNECT, PORT CONFIGURATION, USER MANAGEMENT, ADMINISTRATIVE SETTINGS, NETWORK SETTINGS, and SUPPORT. The 'ADMINISTRATIVE SETTINGS' section is expanded, showing 'Admin Config' as the selected option. The main content area is titled 'ADMINISTRATIVE SETTINGS' and 'Admin Config:'. It contains the following fields: Unit Name (SERIMUX-CS-32E), New Keypad PIN (masked with asterisks), Confirm Keypad PIN (masked with asterisks), Admin TimeOut (15), and Refresh Period (1). A note below these fields reads '(Timeout/Refresh: 0=Never 1-99 Minutes)'. An 'Apply' button is located at the bottom right of the form.

Figure 49- Unit Settings page

Under “ADMINISTRATIVE SETTINGS”, select “Admin Config”. The Admin Config page enables the administrator to define the following characteristics of the SERIMUX.

- Unit Name- the name for the SERIMUX as it will appear in the main menu of the terminal screen (page 10).
- Keypad PIN- the password required to use the keypad on the front of the SERIMUX. Passwords can be any 4 digit value from 0000-9999. The default value is 9999 (4444 on SERIMUX-CS-4). For security purposes, the value entered will be displayed as “\*” (asterisk).
- Confirm Keypad PIN- the password number applied to New Keypad PIN must be accurately re-entered here
- Admin TimeOut- the amount of idle time before the Administrator will automatically log out from the SERIMUX. This time period has a range from 0-99 minutes (0 = no timeout).
- Refresh Period- the time period to elapse before the page being viewed will automatically refresh. The time period can vary from 0-90 minutes (0= never).

### Change Admin Password

The screenshot shows the NTI Network Technologies Incorporated logo at the top. Below it is a navigation menu with the following items: SERIAL PORT CONNECT, PORT CONFIGURATION, USER MANAGEMENT, ADMINISTRATIVE SETTINGS, NETWORK SETTINGS, and SUPPORT. The 'ADMINISTRATIVE SETTINGS' section is expanded, showing 'Change Admin Password' as the selected option. The main content area is titled 'ADMINISTRATIVE SETTINGS' and 'Admin Password:'. It contains the following fields: New Password (masked with asterisks) and Confirm Password (masked with asterisks). An 'Apply' button is located at the bottom right of the form.

Figure 50- Change Admin Password page

Under “ADMINISTRATIVE SETTINGS”, select “Change Admin Password”. On this page the administrator can change the default administrator password from “nti” to a new password (maximum 31 ASCII characters). Once entered, re-enter the new password in the “Confirm Password” block provided.

**NOTE: The password entered will be case sensitive so be sure to note what characters are upper or lower case if any are alphabetical. The password characters are displayed as “\*” (asterisk) characters while entering them.**

**NOTE: If the administrator password is not known, the administrator must re-initialize the SERIMUX following the “Reset SERIMUX Console Switch to default settings” instructions on page 35.**

## Auto Login User

The screenshot shows the NTI Network Technologies Administrative Setup interface. The left-hand navigation menu includes options like SERIAL PORT CONNECT, PORT CONFIGURATION, USER MANAGEMENT, ADMINISTRATIVE SETTINGS, Unit Settings, Admin Timeout, Change Admin Password, Auto Login User (highlighted), Refresh Period, Keypad PIN, Telnet Base Port, and Firmware Update. The main content area is titled 'ADMINISTRATIVE SETUP' and contains a table for 'Auto Login User' configuration.

Auto Login User:					
User No.	User Name	User Enabled	User Logged		
1	User01	Yes	No	<input checked="" type="radio"/>	
2	Larry	Yes	No	<input type="radio"/>	
3	User03	No	No	<input type="radio"/>	
4	User04	No	No	<input type="radio"/>	
5	User05	No	No	<input type="radio"/>	
6	User06	No	No	<input type="radio"/>	
7	User07	No	No	<input type="radio"/>	
8	User08	No	No	<input type="radio"/>	

An 'Apply' button is located at the bottom right of the table area.

Figure 51- Auto Login User page

Under “ADMINISTRATIVE SETTINGS”, select “Auto Login User”. On this page, the administrator will define which user will automatically be logged in to the SERIMUX without a password upon power-up. As long as the user is enabled and has access to the port being used of the auto login, the user may be assigned.

**Telnet Base Port**

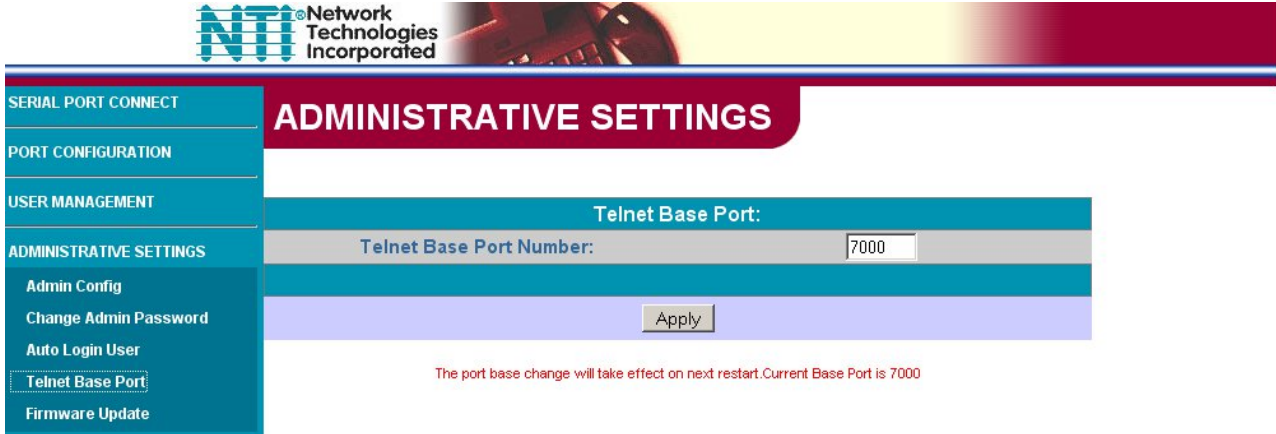

**Figure 52- Telnet Base Port page**

Under “ADMINISTRATIVE SETTINGS”, select “Telnet Base Port”. On this page, the administrator will define the base port number used to access the SERIMUX through Telnet. If the base port number is 7000 (the default value), then ports 1-8 would be identified in Telnet as ports 7001 through 7008 respectively. If the base port is changed, to 7125 for example, then ports 1-8 would be identified in Telnet as ports 7126 through 7133 respectively.

**Note:** *Once the Telnet Base Port number is changed, the SERIMUX must be restarted for the new number to take effect.*

## Firmware Update

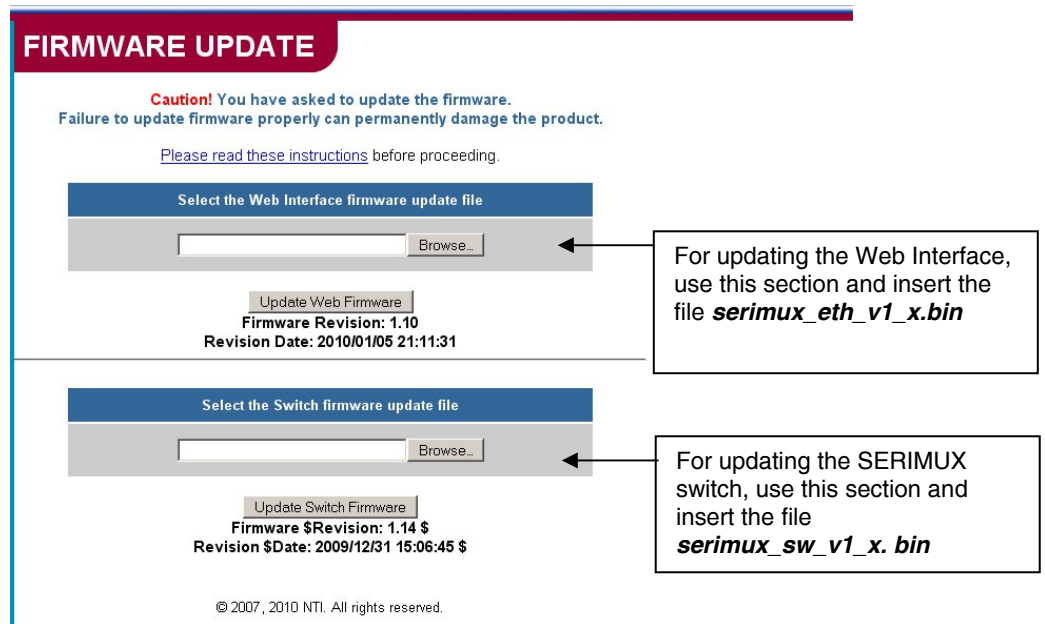

Figure 53- Firmware Update page

Under “ADMINISTRATIVE SETTINGS”, select “Firmware Update”. The Firmware Update page shows the current version of the firmware for the Web interface (Figure 53-upper) and for the SERIMUX switch (Figure 53-lower) and enables the Administrator to update the firmware of the SERIMUX.

**WARNING: Failure to carefully follow these directions can permanently damage the SERIMUX. Please read these directions in full before continuing. Do not, under any circumstances, reset or power-down the SERIMUX while the firmware is being updated. Do not attempt to update the firmware if a power-failure is likely.**

**Note: The Firmware can only be updated from the non-secure (http) website. If you attempt to access this page from the secure (https) website, you will be automatically redirected to the non-secure site.**

To update the firmware:

1. Contact NTI for the latest firmware file and copy it to your computer.
2. On the Update Firmware page, browse to the firmware file.
3. Press *Update Web Firmware* (for the Ethernet Control) or *Update Switch Firmware* (for the LCD).

**Note: If an update is attempted using the wrong firmware for the section an error message will be received. No update will occur.**

4. Wait for the following message to appear (may take several minutes):

*Upload Succeeded  
Flash of new image completed:  
The system will automatically restart.*

5. The SERIMUX will restart itself in 10 seconds, logging out all connections. After approximately 40 seconds, the SERIMUX will be ready to resume operation.

If a message appears stating that the Upload has failed, or that a non-fatal error has occurred:

1. Ensure that the file being uploaded is the NTI firmware file.
2. Repeat the process from step 2 above.

**Note: The following message does not indicate that damage to the product has occurred.**

If a message appears stating that there has been a fatal error:

1. **DO NOT RESET OR POWER-DOWN THE SERIMUX.**
2. Repeat the update process from the first step 2 above.
3. If you get another Fatal Error message, call NTI tech-support at 1-800-742-8324 or 330-562-7070.

**FYI: The SERIMUX should continue to run normally unless it is reset. However, damage may have occurred to the web server firmware that will prevent the product from starting up correctly.**

## Network Settings

### Enterprise Settings

Figure 54- Network Setup-Enterprise Settings page

Under “NETWORK SETTINGS”, select “Enterprise Settings”. From this page, the administrator can enter basic company information.

### IP Configuration

Figure 55- Network Setup- Network Settings page

Under “NETWORK SETTINGS”, select “IP Configuration”. The IP Configuration page will be displayed where the Administrator can either define the network settings manually, or let the DNS information be filled in automatically by the DHCP server.

If using the automatic method, click the radio button for “Obtain an IP address automatically” and press “Apply”. In order for changes made using the automatic method to take effect, the SERIMUX must be power-cycled.

If entering the settings manually, click the radio button for “Use the following IP address”, enter the desired settings in the blocks provided, and press “Apply”. The changes made manually will have immediate effect and the user must login at the new IP address to proceed.



## Support

The “SUPPORT MENU” includes two links;

“Manual”- select to download a pdf copy of the Owner’s manual

“Downloads”- leads to the SERIMUX website containing downloads downloads for SERIMUX firmware upgrades (see pages 50 and 30).

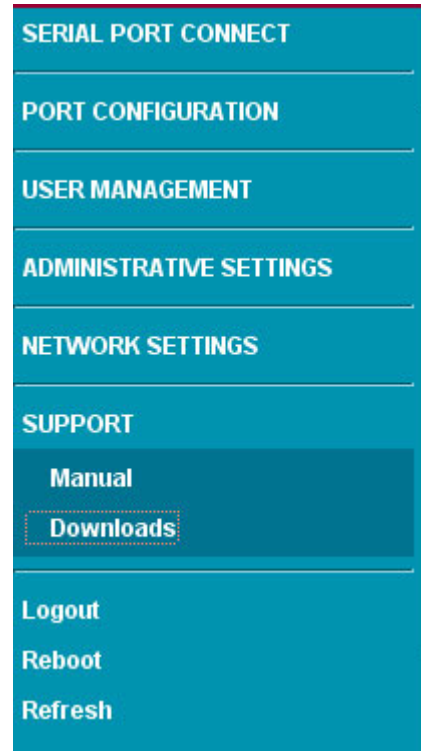

Figure 56- Support page

## Reboot

If a user wants to have the SERIMUX reboot for any reason, the user can select “Reboot” from the side menu (see Figure 56). When “Reboot” is selected, the user will be prompted to confirm the selection. When the reboot is complete, the user will need to login again to resume operation of the SERIMUX.

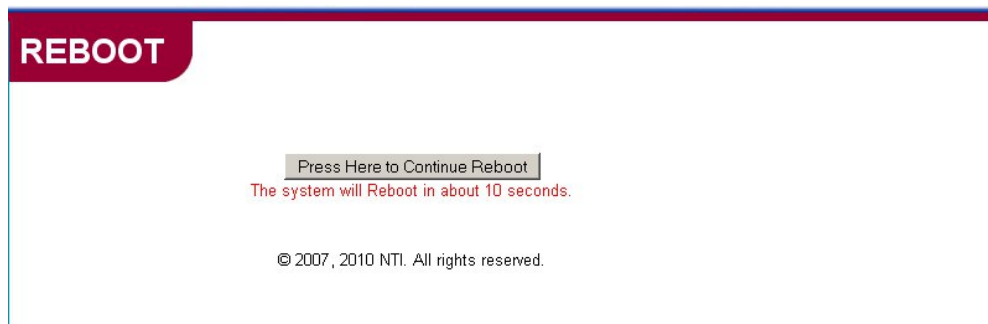

Figure 57- Reboot the SERIMUX from the Web Interface

## Logout

When a user is finished accessing the SERIMUX WEB interface, it is recommended that the user click on the “Logout” link in the side menu. If the “Logout” link isn’t used, the web interface can be accessed by anyone that sits down to the desk where it is logged in until SERIMUX automatically logs the user out. The automatic logout will only occur after 8 hours of access time.

## DEVICE DISCOVERY TOOL

In order to easily locate the SERIMUX on a network, the NTI Device Discovery Tool may be used. The Discovery Tool can be downloaded from <http://www.networktechinc.com/download/d-srvsw-term.html>. To open it just double-click on the file `NTIDiscover.jar`. This will open the NTI Device Discovery Tool.

**Note: The Device Discovery Tool requires the Java Runtime Environment to operate. Here is a [link](#) to the web page from which it can be downloaded. Install Java 7. Do NOT install Java 8.**

**Note: The computer using the Discovery Tool and the SERIMUX must be connected to the same physical network in order for the Device Discovery Tool to work.**

When you load the Device Discovery Tool, an applet should load. Accept the Certificate to allow this applet access to your network.

Press the button entitled “Detect NTI Devices” to start the discovery process. After a few seconds, the tool will display all NTI devices on the network, along with their network settings.

**Note: Do not close this webpage while the NTI Discovery Tool is running. Close the NTI Device Discovery Application first, then this webpage.**

### How To Use the Discovery Tool

**Note: If more than one device is discovered by the tool, the following instruction only applies to the SERIMUX. Most of the instruction that displays when the Discovery Tool opens does not apply to the SERIMUX.**

To temporarily change the network settings for a SERIMUX,

1. type in new settings in the boxes provided (see below)
2. press the **Enter** key or the **Submit** button.
3. Press the **Close** button to close the Discovery Tool.

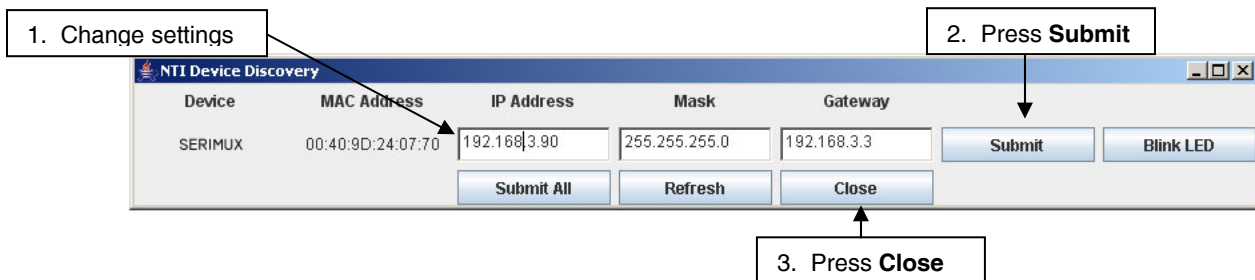

Figure 58- Device Discovered

Use your browser to access the SERIMUX as described on page 36.

**Note: Be sure to go to the IP Configuration page (page 51) and permanently change the settings as desired. The settings changed by the Discovery Tool are temporary. If the SERIMUX is power cycled (or the Reset button is pressed (page 58), the SERIMUX will return to the last settings saved on the IP Configuration page.**

## COMMAND LINE INTERFACE

The Administrator can remotely view or change port configuration in the SERIMUX using a Telnet client and the Command Line Interface (CLI) connected through a network. Using pre-formatted configuration files, the SERIMUX can quickly be re-configured as needed.

**Note: The Ethernet option must be present in the SERIMUX for this feature to function.**

1. Make sure the SERIMUX is powered-ON, connected to the network, and has an assigned IP address (page 51). The default IP address is 192.168.1.90.
2. Start the Telnet client (like HyperTerminal) from a PC connected on a network in which the SERIMUX is accessible and configure it as follows:
  - TCP/IP connection
  - Enter the IP address assigned to the SERIMUX
  - ANSI or VT100 terminal mode.

With the Telnet client properly configured, you will immediately connect to the SERIMUX and be prompted for the administrator username, and then the password.

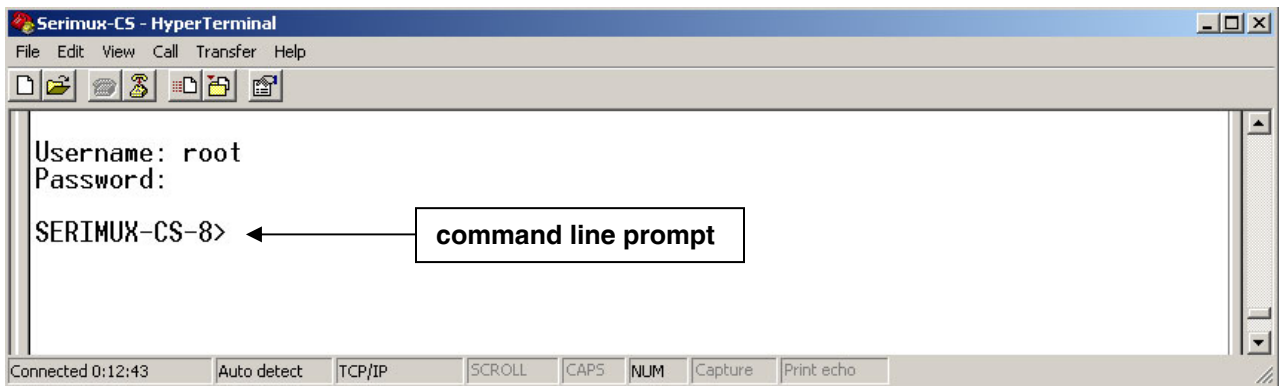

Figure 59- Command Line Interface login

**User Name = administrator or root** (lower case letters only)

**Password = nti** (lower case letters only)

With a successful login, the SERIMUX command line prompt will appear. If the wrong password is entered, the message "Access denied" will appear.

**Note: If the password is lost or forgotten, reset the SERIMUX following the "Reset SERIMUX Console Switch to default settings" instructions on page 35.**

**Note: Only one user at a time can access the Command Line Interface in the SERIMUX.**

From the command line prompt, type <help> to be shown a list of commands that can be used to control the SERIMUX.

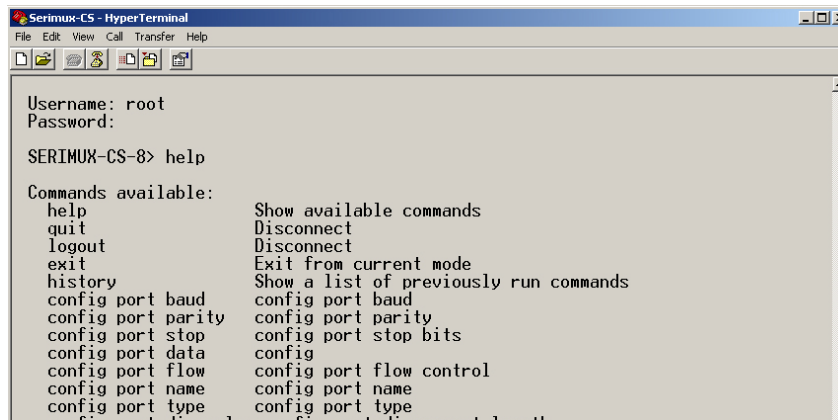

Figure 60- List of CLI commands

List of CLI Commands:

Command	Purpose	Command	Purpose
help	Show available commands	reset port	reset port settings
quit	Disconnect	reset modem	reset modem settings to factory default
logout	Disconnect	reset user	reset user settings to default
exit	Exit from current mode	update web_firmware	update web firmware
history	Show a list of previously run commands	update switch_firmware	update switch firmware
config port baud	config port baud	show port	show port settings
config port lfsuppress	config port linefeed suppress	show port baud	show port baud
config port parity	config port parity	show port parity	show port parity
config port stop	config port stop bits	show port stop	show port stop bits
config port data	config port data bits	show port data	show port data bits
config port flow	config port flow control	show port flow	show port flow control
config port name	config port name	show port name	show port name
config port type	config port type	show port type	show port type
config port disconlen	config port disconnect length	show port disconlen	show port disconnect length
config port discon1	config port disconnect 1 char	show port discon1	show port disconnect 1 char
config port discon3	config port disconnect 3 char	show port discon3	show port disconnect 3 char
config port timeout	config port timeout	show port timeout	show port timeout
config port auth	config port authentication method	show port auth	show port authentication method
config port breakenable	config port break enable status	show port breakenable	show port break enable status
config port breaklen	config port break length	show port breaklen	show port break length
config port xon	config port xon char	show port xon	show port xon char
config port xoff	config port xoff char	show port xoff	show port xoff char
config port dtr	config port dtr on connect	show port dtr	show port dtr on connect
config port interchar	config port interchar delay	show port interchar	show port interchar delay
config modem init	config port modem init string	show modem	show modem
config modem hangup	config port modem hangup string	show modem init	show port modem init string
config modem reset	config port modem reset string	show modem hangup	show port modem hangup string
config modem nocarrier	config port modem hangup on no carrier	show modem reset	show port modem reset string
config user name	config user name	show modem nocarrier	show port modem hangup on no carrier
config user password	config user password	show user	user settings
config user level	config user level	show user name	show user name
config user enable	config user enable	show user level	show user level
config user timeout	config user timeout	show user enable	show user enable
config user initmenu	config user init menu	show user timeout	show user timeout
config user portaccess	config user port access list	show user initmenu	show user init menu
config admin timeout	config admin timeout	show user portaccess	show user port access list
config admin keypadpin	config keypad pin	show admin timeout	show admin timeout
config admin refresh	config admin refresh time	show admin keypadpin	show keypad pin
config admin password	config admin password	show admin refresh	show admin refresh time
config admin autouser	config auto user to login	show admin autouser	show auto user to login
config switch ipaddr	config switch ip address	show switch ipaddr	show switch ip address
config switch netmask	config switch network mask	show switch netmask	show switch network mask
config switch gateway	config switch default gateway address	show switch gateway	show switch default gateway address
config switch dns	config primary dns	show switch dns	show primary dns
config switch dns1	config primary dns1	show switch dns1	show primary dns1
config switch dhcp	config dhcp for auto ip addr	show switch dhcp	show dhcp for auto ip addr
config switch name	config switch/host name	show switch name	show switch/host name
config switch telnetbaseport	config telnet base port	show switch telnetbaseport	show telnet base port
reboot	reboot system	show firmware	firmware revision
disconnect user	disconnect user	show config	config compared to default settings
disconnect port	disconnect port		

Using these commands, the administrator can create text files to send to the SERIMUX to perform groups of commands for special functions or to configure the SERIMUX. Once created, the text files can be archived, ready for reuse at any time.

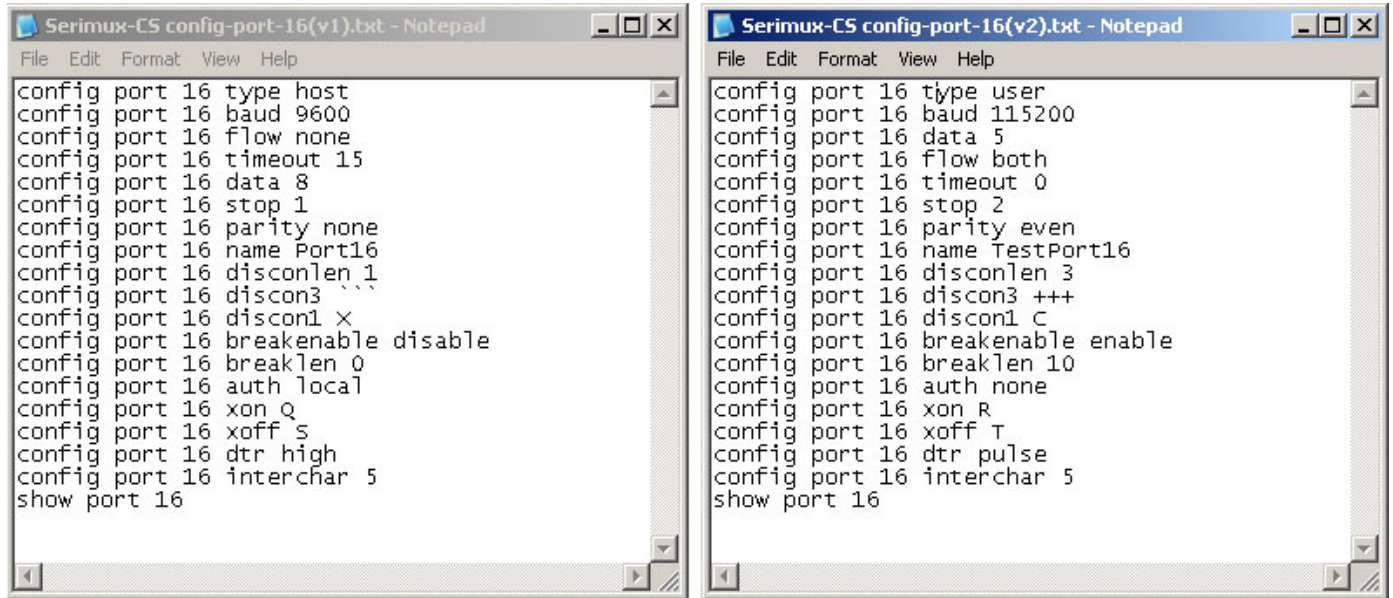

Figure 61- Sample txt files for configuring Port 16

The examples in Figure 62 show two text files for configuring port 16 in two different ways. With a text file written to perform the desired functions, the text file can be sent to the SERIMUX through the Telnet client. Using HyperTerminal, for example, in the menu at the top select “File”, then “Send File”, then browse for and select the desired text file and press <Enter>. All commands in the txt file will be sent to the SERIMUX.

Commands or groups of commands can effect multiple ports at the same time. In the examples above, to configure all ports with those settings instead of just port 16, change “16” to “all”. To configure ports 1 and 16, change “16” to “1,16” (add “1” and a comma). To configure ports 1 through 4 all the same, change “16” to “1-4” (add “1” and a hyphen).

## Helpful Hints

- Only one user can access the CLI at a time.
- Most of the parameters can be set or viewed using the `config` or `show` command.
- Context sensitive Help is available for all commands on double-tab. This will list the options available for the current commands. (Ex. With the command `config port 16 baud <Tab> <Tab>`, the response will be to show the command options and syntax of the baud rates that can be set for port 16.)
- A history of the previous 16 commands is available. Press the <Up arrow> key to navigate through previous commands.
- All commands can be listed using the <help> command.
- A `config` command is successful if it does not return any error messages.
- Some of the commands like `ip address`, `dhcp`, and `telnet base port` requires a reboot (you will be prompted to reboot).
- Various options for Arguments for List operations are available.

### Examples:

Command	Response
show port 1	Will show all settings for port 1
show port 1,2,3	Will show all settings for ports 1, 2, and 3
show port 1,4-10	Will show all settings for ports 1 and 4 through 10.
show port *	Will show all settings for all ports
show port all	Will show all settings for all ports

## Update Firmware from CLI

In addition to being able to update the firmware using the Web Interface (page 50) or the menus in Serial Control (page 30), the firmware for the SERIMUX can also be updated from the CLI.

1. Place the new firmware files (both web and switch) on a host machine with a tftp server running. (Names of the files can be changed to whatever is suitable.)
2. From the command line issue commands to update web and switch firmware respectively.

### Format:

```
update web_firmware %host_ip_addr% %file_name%  
update switch_firmware %host_ip_addr% %file_name%
```

The firmware file is downloaded to the SERIMUX and written to flash memory. This may take up to 5-10 minutes. System will go to auto reboot within 10 seconds of each completed update.

### Example:

IP address of Host on which the tftp server is running : 192.168.3.151  
Web firmware filename : serimuxweb\_update.bin  
Switch firmware filename : serimuxswitch\_update.bin

**Note: These are the same files referred to in the Web Interface Firmware Update section (page 50).**

1) For web interface

```
command -> update web_firmware 192.168.3.151 serimuxweb_update.bin  
Response -> Please wait while updating web firmware.  
Response -> Web Firmware update successful. System will now reboot.
```

2) For switch firmware

```
command -> command -> update switch_firmware 192.168.3.151 serimuxswitch_update.bin  
Response -> Please wait while updating switch firmware.  
Response -> Switch Firmware update successful. System will now reboot.
```

# RESET BUTTON

The "RESET" button on the back of the SERIMUX may be used for power cycling the SERIMUX processor without actually power cycling the rest of the SERIMUX.

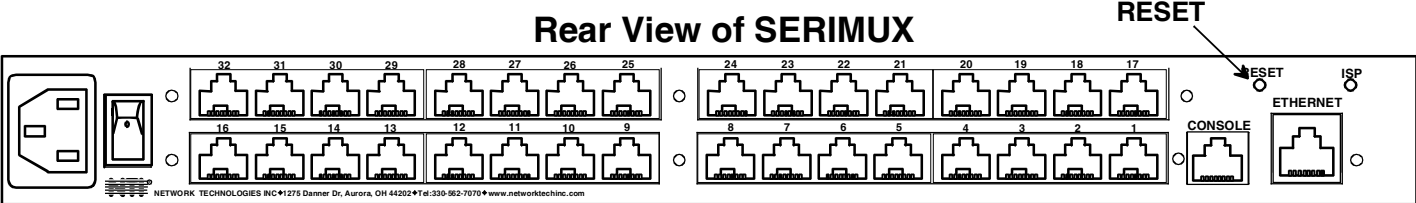

Figure 62- Location of RESET button

## INTERCONNECTION CABLE WIRING METHOD

The cable connecting the terminals and devices to the SERIMUX must be terminated with RJ45 connectors and must be wired according to the EIA/TIA 568 B industry standard. Wiring is as per the table and drawing below.

Pin	Wire Color	Pair	Function
1	White/Orange	2	T
2	Orange	2	R
3	White/Green	3	T
4	Blue	1	R
5	White/Blue	1	T
6	Green	3	R
7	White/Brown	4	T
8	Brown	4	R

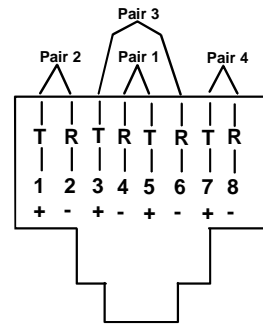

Figure 63- View looking into RJ45 female

## TROUBLESHOOTING

If the Console Switch is not working properly, consider the suggestions below to see if a solution can be found.

Problem	Cause	Solution
No Front Panel LEDs are illuminated SERIMUX is not working properly	No power to SERIMUX	Check all power connections
Cannot Connect to port/device	<ul style="list-style-type: none"> <li>Poor Connections</li> <li>Port not configured correctly</li> <li>Ports not initialized</li> </ul>	<ul style="list-style-type: none"> <li>Verify that all cables are securely connected</li> <li>Verify that the port configuration matches that of the device connected</li> <li>Power-up the CPUs first, then the SERIMUX</li> </ul>
Commands entered from front panel keypad are not accepted	<ul style="list-style-type: none"> <li>Port settings not correct</li> <li>Wrong cable adapter used</li> <li>Connections are loose</li> <li>Wrong serial cable pinout</li> </ul>	<ul style="list-style-type: none"> <li>Verify proper communication settings (page 8)</li> <li>Verify that adapter is one specified in Appendix C.</li> <li>Verify that all cable connections are secure</li> <li>If using straight-thru connections, try a crossover cable (RJ45MF-RS232-CO); If crossover, try a straight through serial connection. See page 6.</li> </ul>
SERIMUX will not accept username or password	Buttons are being pressed too rapidly	<ol style="list-style-type: none"> <li>Make sure the Keypad PIN is entered properly.</li> <li>Press the "Enter" key before typing the PIN to discard the previous entry.</li> <li>Try the PIN again but slow down the button sequence- approx 1/2 sec between each press.</li> </ol>
SERIMUX will not accept username or password	Usernames and passwords are case sensitive	Verify characters used and enter again.
Cannot access user menu on a port	Port is configured as host port	Configure port as user port. (page 39)
I cannot access the View Port Data Buffer	Only the ROOT user can access this (see page 17)	Login as the ROOT user

If the passwords or other important parameters are not available, the SERIMUX Console Switch can be re-initialized to the default settings (see "Initialize SERIMUX Console Switch to default settings" on page 35).

***Caution: During initialization, the customer modified parameter values will be replaced with the factory default values; all ports will be placed in buffer mode; all passwords will be erased.***

If the suggestions above have been tried and the NTI Console Switch is still not functioning properly, a solution to the problem may be found on our website at <http://www.networktechinc.com> in our FAQ (Frequently Asked Questions) section, or, please call us directly at (800) 742-8324 (800-RGB-TECH) in the US & Canada or (330) 562-7070 (Worldwide) and we'll be happy to assist in any way we can.



**Appendix A - SERIMUX Port Characteristics**

Every port is defined through the following parameters:

Description	Acceptable Value	Default Value
Number	0-8/16/24/32	Same (not changeable)
Name	Up to 15 characters	"Port00" to "Port32"
Type – port 0	User	User (not changeable)
Type – except port 0	User or Host	Host
Baud rate – port 0	300-115200	9600
Baud rate – except port 0	50-128000	9600
Data bits per character – port 0	7,8	8
Data bits per character – except port 0	5,6,7,8	8
Stop bits – port 0	1, 2	1
Stop bits – except port 0	1, 1-1/2, 2	1
Parity	No parity, even, odd	No parity
Handshake mode (flow control)	Xon / Xoff (or in-band, or software), RTS/CTS (or out-band or hardware), Both, None	None
Xon character	any ASCII nonprintable character (0-31 range)	Ctrl+Q (17)
Xoff character	any ASCII nonprintable character (0-31 range)	Ctrl+S (19)
Inter-character delay – except port 0 (no delay allowed on port 0)	1-60 milliseconds, none	None
Line break receive allowance – except port 0 (no allowance for port 0)	Yes or No	No
Transmitted line break extra duration (added to 1 character transmission time) – except port 0 (no extra duration for port 0)	No break transmitted, 1-999 milliseconds	No break transmitted
In-band disconnect sequence	0 (disabled), 1, or 3 characters sequence	1-char sequence
1 character disconnect sequence	Any ASCII nonprintable character (0-31 range)	Ctrl+X (24)
3 character disconnect sequence	Any 3 ASCII characters	``` (3 back quotes)
Connection timeout	1-90 minutes, never	15 minutes
DTR output upon disconnect	Low, high, or pulsed for 0.5 seconds and then held high	High
Modem Reset string	Up to 41 characters	ATZ
Modem Initialization string	Up to 41 characters	AT&F&C1&D2S0=0
Modem Disconnect string	Up to 41 characters	ATH

**Appendix B - SERIMUX User and Administrator Characteristics**

The users and the administrator are defined through the following parameters:

Description	Acceptable Value	Default Value
<b>Users:</b>		
User number	1 to 32	Same (not changeable)
User name	Up to 15 characters – case sensitive	"User01" to "User32"
User password	Up to 31 characters – case sensitive	"" (empty string)
User enabled	Yes or No	Not enabled, except User 1: enabled
Administrative privileges	Yes or No	No
Access to ports	Port 0 always; Ports 1-31	Port 0, except User 1: all ports
User menu timeout	1-90 minutes, never	15 minutes
<b>Administrator:</b>		
Administrator name	"ADMINISTRATOR" or "ROOT" – case sensitive	Same (not changeable)
Administrator password	Up to 31 characters – case sensitive	"NTI"
Administrator menu timeout	1-90 minutes, never	15 minutes
User to auto login	User 1-32, None	User 1

**Appendix C- Cable Adapters**

Four cable adapters are included with the SERIMUX with RJ45 connectors (to purchase more please contact NTI at (800) 742-8324 (800-RGB-TECH) or (330) 562-7070). The following illustrations show cable adapter pin outs.

**DB-25 Male Console Adapter (NTI P/N DB25M-RJ45F-T)**

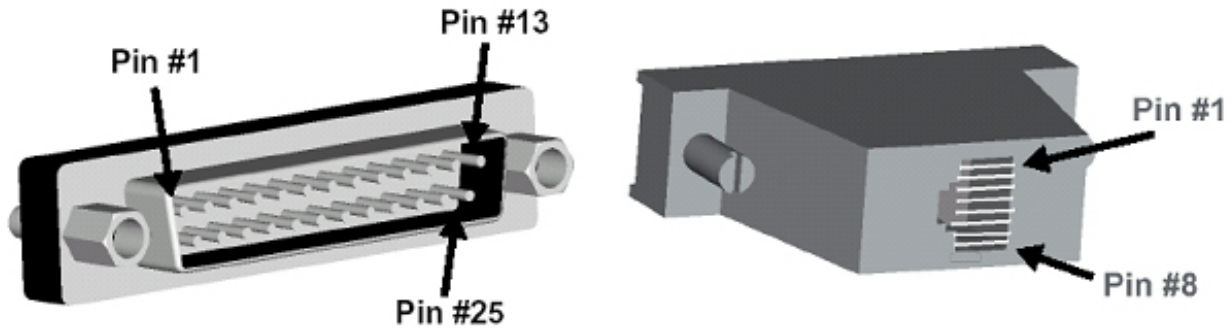

**DB-25 Male to RJ45 Connector Pin Assignments**

RJ45	Signal		DB-25M	Signal
1	CTS	Connected to	4	RTS
2	DSR	Connected to	20	DTR
5	DCD			
3	RxD	Connected to	2	TxD
4	GND	Connected to	7	GND
6	TxD	Connected to	3	RxD
7	DTR	Connected to	6	DCD
			8	DSR
8	RTS	Connected to	5	CTS

**DB-9 Female Console Adapter (NTI P/N DB9F-RJ45F)**

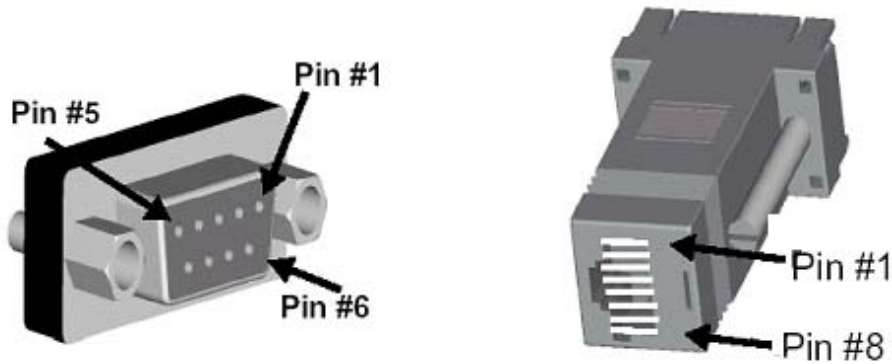

**DB-9 Female to RJ45 Pin Assignments**

RJ45	Signal		DB-9F	Signal
1	CTS	Connected to	7	RTS
2	DSR	Connected to	4	DTR
5	DCD			
3	RxD	Connected to	3	TxD
4	GND	Connected to	5	GND
6	TxD	Connected to	2	RxD
7	DTR	Connected to	1	DCD
			6	DSR
8	RTS	Connected to	8	CTS

**DB-25 Female Console Adapter (NTI P/N DB25F-RJ45F)**

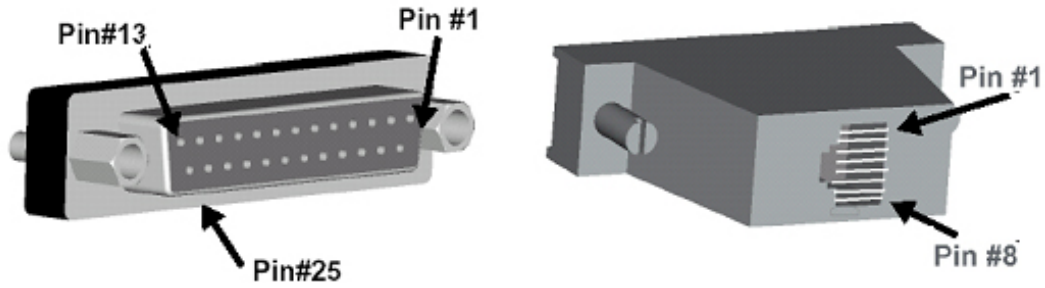

**DB-25 Female to RJ45 Pin Assignments**

RJ45	Signal		DB-25F	Signal
1	CTS	Connected to	4	RTS
2	DSR	Connected to	20	DTR
5	DCD			
3	RxD	Connected to	2	TxD
4	GND	Connected to	7	GND
6	TxD	Connected to	3	RxD
7	DTR	Connected to	6	DCD
8	RTS		8	DSR
		Connected to	5	CTS

**DB-25 Male Modem Adapter (NTI P/N DB25M-RJ45F-C)**

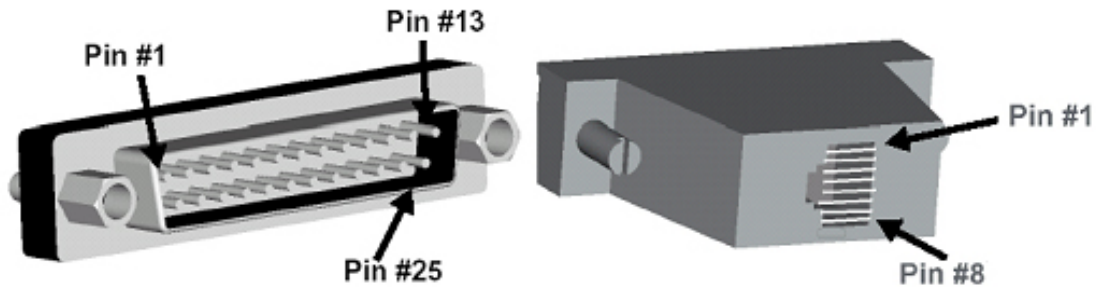

**DB-25 Male Modem to RJ45 Pin Assignment**

RJ45	Signal		DB-25M	Signal
1	CTS	Connected to	5	CTS
2	DSR	Connected to	6	DSR
3	RxD	Connected to	3	RxD
4	GND	Connected to	7	GND
5	DCD	Connected to	8	DCD
6	TxD	Connected to	2	TxD
7	DTR	Connected to	20	DTR
8	RTS	Connected to	4	RTS

### Ethernet Pinouts

The SERIMUX with RJ45 connectors uses a standard Ethernet connector that is a shielded and compliant with AT&T 258 specifications.

Pin	Description
1	Tx+
2	Tx-
3	Rx+
4	NC
5	NC
6	Rx-
7	NC
8	NC

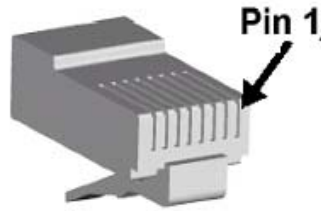

## SPECIFICATIONS

DESCRIPTION	SPECIFICATION
Connectors	RJ45 Female DTE configuration via RS232
Operating temperature	32°F - 100°F (0°C - 38°C) (17-90% non-condensing RH)
Storage temperature	-20°F - 140°F (-30°C - 60°C). (17-90% non-condensing RH)
Power requirements	100-240VAC, 50 or 60Hz
Size (In.) WxDxH	15.25x6x1.75 without rack ears mounted 19x6x1.75 with rack ears mounted

## INDEX

- Accessible host list, 25
- Administrative settings**, 47
- Advanced settings**, 21, 24
- ANSI, 1
- cable adapters, 61
- cable connections, 6
- Change Admin Password, 48
- clear port buffer, 39
- CLI commands list, 55
- Command line interface**, 54
- connect two host ports, 38
- copy port settings, 43
- definitions, 2
- Device Discovery Tool**, 53
- disconnect port, 37
- disconnect user, 44
- Dual Power, 7
- Enterprise settings, 51
- Ethernet connection**, 6
- Firmware menu, 22, 23
- Firmware upgrade**, 30, 50
- interconnection cable, 59
- IP address, 36
- IP configuration, 51
- ISP button, 4
- Keypad control**, 9, 32
- Keypad PIN**, 3, 9, 21, 47
- LAN, 36
- login, 9, 10
- Main menu**, 10
- modem settings, 16, 42
- network settings, 23, 51
- password, 3, 9, 36
- Password-change**, 21, 23
- port access, 20
- port configuration, 37
- Port List, 11
- port settings**, 13, 40
- Quick start**, 8
- rack mounting, 5
- reboot**, 24, 52
- serial communications, 9
- Serial Control**, 9
- serial port characteristics, 60
- serial settings, 41
- telnet base port, 49
- terse mode**, 19, 28
- Troubleshooting**, 59
- User main menu, 26
- user name, 3
- User port list, 27
- User serial controls**, 25
- User settings**, 19
- username and password, 36
- view user list, 44
- VT100, 1
- web browsers, 2
- Web Interface**, 36

## WARRANTY INFORMATION

The warranty period on this product (parts and labor) is two (2) years from the date of purchase. Please contact Network Technologies Inc at **(800) 742-8324** (800-RGB-TECH) or **(330) 562-7070** or visit our website at <http://www.networktechinc.com> for information regarding repairs and/or returns. A return authorization number is required for all repairs/returns.