



NTI NETWORK
TECHNOLOGIES
INCORPORATED

1275 Danner Dr Tel:330-562-7070
Aurora, OH 44202 Fax:330-562-1999
www.networktechinc.com

UNIMUX Series

UNIMUX-HD4K18GB-x

4K 18Gbps Video USB KVM Switch

Installation and Operation Manual



UNIMUX-HD4K18GB-8 (Front and Rear View)



UNIMUX-HD4K18GB-32 (Front and Rear View)



UNIMUX-HD4K18GB-16 (with included cable management tray)



UNIMUX-HD4K18GB-32 (with included cable management trays)

TRADEMARK

UNIMUX and the NTI logo are registered trademarks of Network Technologies Inc in the U.S. and other countries. All other brand names and trademarks or registered trademarks are the property of their respective owners.

COPYRIGHT

Copyright © 2024 by Network Technologies Inc. All rights reserved. No part of this publication may be reproduced, stored in a retrieval system, or transmitted, in any form or by any means, electronic, mechanical, photocopying, recording, or otherwise, without the prior written consent of Network Technologies Inc, 1275 Danner Drive, Aurora, Ohio 44202.

CHANGES

The material in this guide is for information only and is subject to change without notice. Network Technologies Inc reserves the right to make changes in the product design without reservation and without notification to its users.

FIRMWARE VERSION

Current Firmware Version 1.01

Typographic Conventions

The table below offers examples of text format and its meaning when that format is used in place of the standard font (Helvetica) used throughout this manual.

Typeface meaning	Font Configuration	Example
On-screen computer output	Courier New-(not bold)	C:>
What you type on the computer	Courier New-bold	C:> edit text.bat

TABLE OF CONTENTS

INTRODUCTION	1
MATERIALS	2
FEATURES AND FUNCTIONS.....	3
Install Cable Management Tray	4
RACKMOUNTING INSTRUCTIONS.....	5
To Mount to a Rack	5
INSTALLATION.....	6
RS232 Connection.....	8
Power-Up Sequence.....	9
Limitations.....	9
USING THE UNIMUX SWITCH	10
Front Panel Control.....	10
Keyboard Control.....	10
User Access Functions.....	11
Command Mode	11
Navigation	11
Settings Menu	12
Broadcast Mode.....	13
Scan Mode.....	14
Normal Mode	15
Administrator Settings.....	16
Port Name List	17
Hot Keys	18
RS232 CONTROL.....	19
RS232 Connections and Configuration	19
Remote Connection	19
Baud Rate	19
Command Protocol	19
NTI Switch Control Program For Windows 7, 8,10 and 11	20
SerTest- RS232 Interface Test Program	21
Main Options.....	21
Firmware Update	23
KEYBOARD FEATURES	25
Keyboard-To-Computer Translation	25
Translation Capabilities	25
TROUBLESHOOTING	26
TECHNICAL SPECIFICATIONS.....	27
INDEX.....	28
WARRANTY INFORMATION.....	28

TABLE OF FIGURES

Figure 1- Install cable management tray(s).....	4
Figure 2- Secure rackmount ears to switch.....	5
Figure 3- Secure switch to a rack.....	5
Figure 4- Connect a HDTV monitor.....	6
Figure 5- Connect the device(s).....	6
Figure 6- Connect the AC line cord.....	7
Figure 7- Connect each CPU	7
Figure 8- Connect Terminal for RS232 Control.....	8
Figure 9- Compatible device combinations	9
Figure 10- Port List (Main Menu)	11

Figure 11- Help Menu.....	12
Figure 12- Settings Menu	12
Figure 13- Stop USB Device Reminder warning.....	13
Figure 14- Settings Menu	13
Figure 15- Broadcast List	14
Figure 16- Settings Menu	14
Figure 17- Scan List	15
Figure 18- Administrator Settings.....	16
Figure 19- Port Name List	17
Figure 20- Settings Menu	18
Figure 21- Front Panel Mode LEDs	18
Figure 22- RS232 Communication Illustrated	19
Figure 23- Keyboard Layouts	25

INTRODUCTION

The UNIMUX™ 4K 18Gbps HDMI USB KVM Switch allows a user to control up to 32 HDMI 2.0 Ultra-HD 4Kx2K 60Hz 4:4:4 USB computers with one USB keyboard, USB mouse, and 4K HDMI monitor. Dedicated internal microprocessors emulate keyboard and mouse presence to each attached CPU 100% of the time so all computers boot error-free.

- Supports Ultra-HD 4Kx2K resolutions to 3840x2160 and 4096x2160 @24/30/60Hz RGB/YUV 4:4:4, HDTV resolutions to 1080p @120Hz, and up to 1920x1200 (WUXGA).
- HDMI features supported:
 - HDMI 2.0
 - Up to 12-bit Deep Color on input and 8-bit on output.
 - Dolby TrueHD, DTS-HD Master Audio, Dolby Digital, Dolby Digital+, Dolby Atmos, LPCM 2/5.1/7.1CH, DTS 5.1, and DTS:X
 - RGB, YUV 4:4:4, YUV 4:2:2, and YUV 4:2:0
 - Bandwidth up to 600 MHz (18Gbps)
 - 3D (1080p @60Hz)
 - HDR
- HDCP 2.2 compliant.
- Features NTI's patented true autoboot USB switching – all attached computers can be booted simultaneously.
- Compatible with USB computers (PC and MAC) with HDMI outputs.
- Control the switch through the front panel buttons, keyboard commands, OSD, or RS232.
- Two transparent USB 2.0 ports, in addition to keyboard and mouse ports, for connecting USB devices such as printers, game controllers, USB flash drives, touch screen monitors, whiteboards, etc.
 - Supports high-speed (480 Mbps), full speed (12 Mbps), or low speed (1.5 Mbps) USB devices.
- Supports Plug-n-Play specification.
- High quality steel construction.
- Flash upgradeable.
- Rackmount kit included.
- Cable management tray included.

MATERIALS

Materials supplied with this kit:

- NTI UNIMUX-HD4K18GB-x (4,8,16,24 or 32 ports) 4K 18Gbps Video USB KVM Switch
- Line cord, country specific
- Rack mount kit
- 1- DB9 Female-to-RJ45 Female adapter
- 1- 5 foot RJ45-to-RJ45 CAT5 patch cable
- 4- Rubber feet
- Cable Ties (Qty= # of Ports + 2)
- Cable Management Tray with four #6-32 x 1/4" flat head screws (x2 for 24 and 32 port units)

Materials *Not* supplied but **REQUIRED**:

- HD-xx-MM cable for each 4K monitor being connected to the switch and for each PC being connected- available in 3,6,10, 15,25,30,and 50 foot lengths

NOTE: Only supports up to 10 foot lengths for 4Kx 2K@60Hz resolutions and up to 50 foot cables for 1080p

- DVI-HD-1/2/3/5M-MM cable for applications where the video source is DVI- available in 1,2,3 and 5 meter lengths.
 - Supports resolutions to 1080p.
- DP-HD-xx-MM cable for applications where the video source is DisplayPort- available in 3,6 and10 foot lengths

**NOTE: Only supports up to 10 foot lengths for 4Kx 2K@60Hz resolutions
Supports up to 1080p@60Hz for MAC computers.**

- HD-ACT-xx-MM 4K HDMI Active Cables for connection of an HDMI computer or display up to 100 feet away. Available in 20,25,30,40,50,60,75 and 100 foot lengths.
 - Supports 4K@60Hz up to 60 feet on input and output connections
 - Supports 4K@30Hz up to 100 feet on output connections and up to 75 feet on input connections.

where:

xx is the length of the cable in feet

MM indicates male-to-male connector

- USB2-AB-x-5T male USB Type A to male USB Type B interface cable for each USB device being connected to the switch. Many are available from NTI in 0.5 meter and 3,6,10 and 15 foot lengths. Go to <https://www.vpi.us/c/2-0-usb-cables-159>.

Cables can be purchased from Network Technologies Inc by calling **(800) 742-8324 (800-RGB-TECH)** in the US and Canada or **(330) 562-7070 (worldwide)**.

FEATURES AND FUNCTIONS

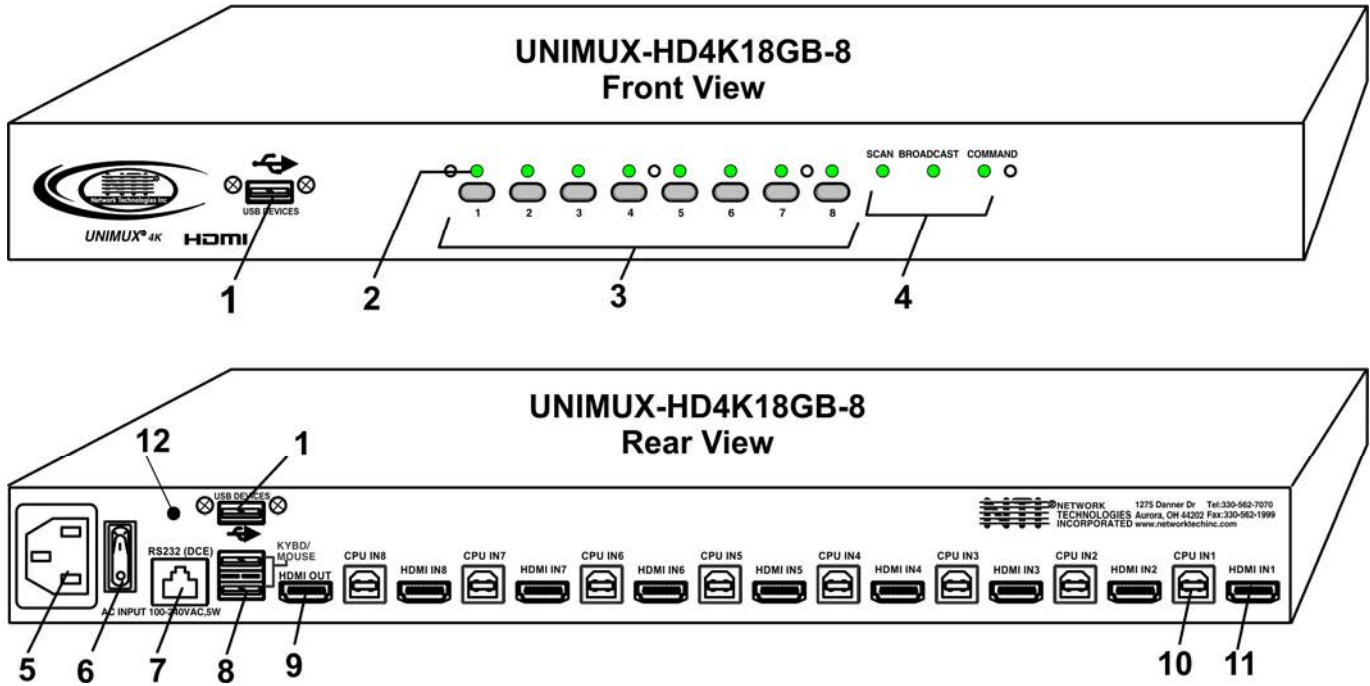

Item	Type	Description
1	USB Type A Female	Transparent USB port for connecting low-, full-, or high-speed USB 2.0 devices
2	LEDs	For visual indication of connection between the user and a specific CPU.
3	Switches	Push to manually switch to a specific CPU or change the switch operating mode
4	LEDs	For visual indication of switch operating mode
5	IEC Connector	For attachment of country-specific power cord
6	Power Switch	To control the ON/OFF function of the switch
7	RJ45 Female	RS232 (DCE) connection for attachment of RS232 control cable
8	USB Type A Female	For connection of user USB device(s)
9	HDMI Female	For connection of user monitor cable
10	USB Type B Female	For connection of USB device cable from CPUs
11	HDMI Female	For connection of video cable from CPUs
12	Button	For performing firmware updates

INSTALL CABLE MANAGEMENT TRAY

Your UNIMUX KVM Drawer comes with a cable management tray to provide a means of securing the cables that plug into the rear of the USB KVM Switch. For 24 or 32 port units, two trays are provided, one to mount at the bottom and one at the top of the case.

Install the cable management tray(s) using the #6-32 x 1/4" flat head screws provided.

Use the cable ties (supplied) to secure the cables to the tray. Securing the cables will help to insure optimum performance.

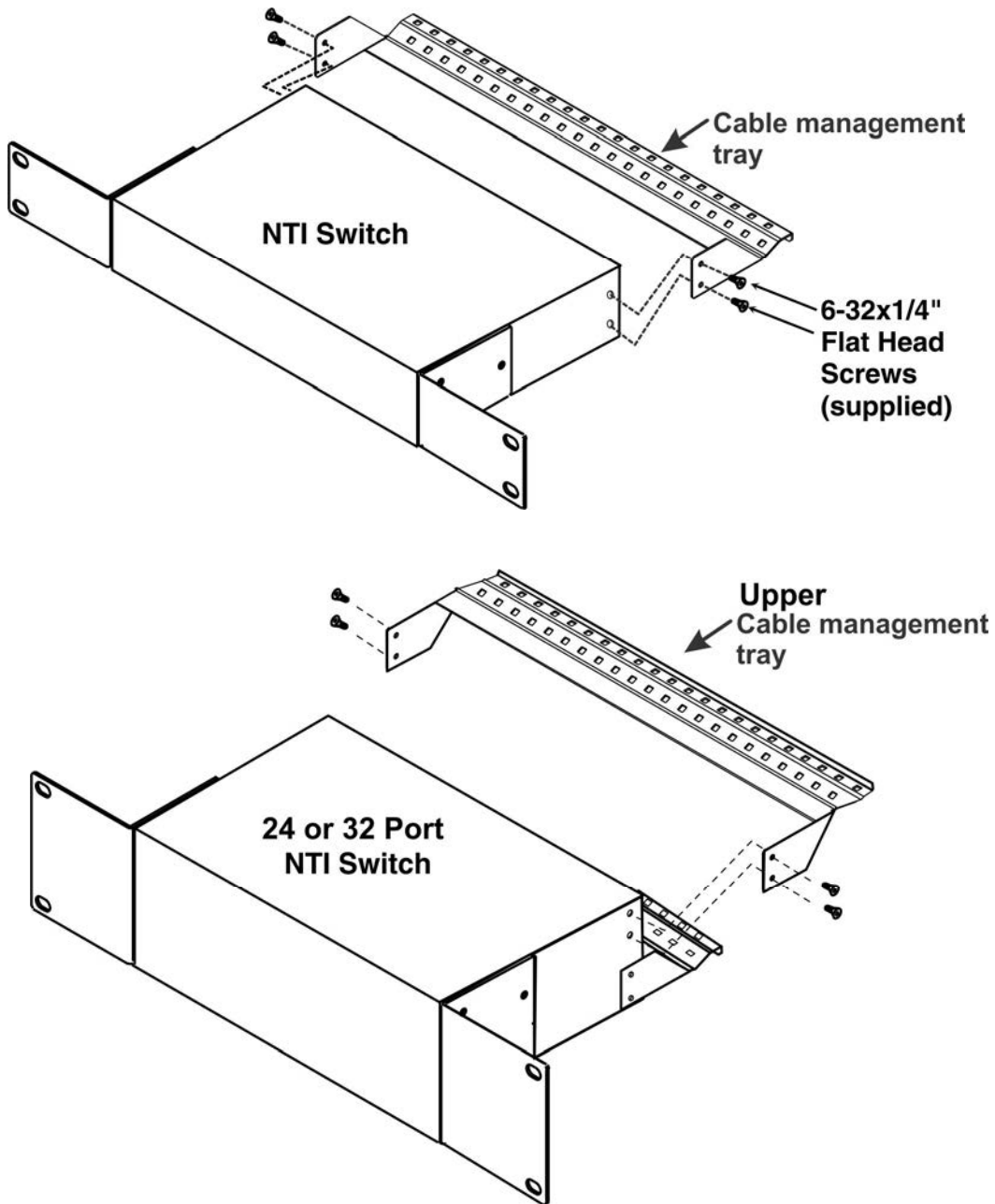

Figure 1- Install cable management tray(s)

RACKMOUNTING INSTRUCTIONS

This NTI switch was designed to be mounted to a rack or to sit on a desktop. It includes rackmount ears to make attachment to a rack easy, and rubber feet to be applied to the bottom of the case if it will instead sit on a flat surface. If this will sit on a flat surface, simply apply the rubber feet to the bottom of the case in each of the 4 corners.

To Mount to a Rack

1. Attach the ears to the switch using the 6-32x3/16" flat Phillips-head screws (6) provided as shown in the illustration below. The holes in the ears should line up with pre-threaded holes in the sides of the NTI switch. Tighten the screws securely.

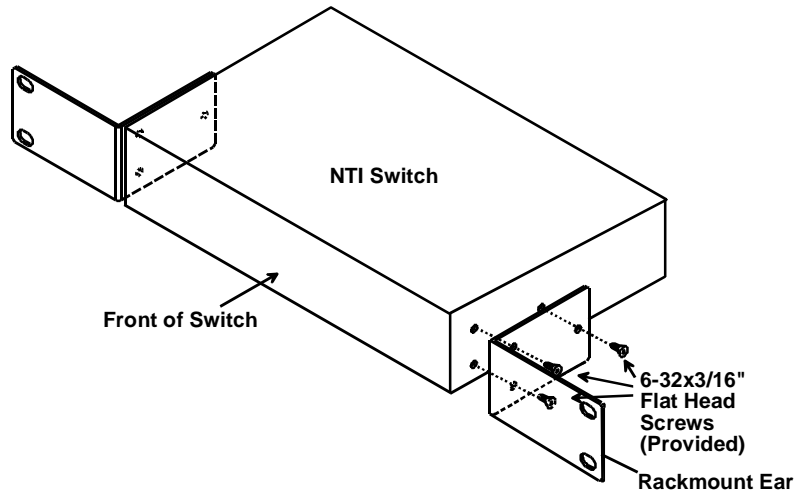

Figure 2- Secure rackmount ears to switch

2. Install 4 captive nuts (not provided) to the rack in locations that line up with the holes in the mounting ear on the NTI switch.
3. Secure the NTI switch to the rack using four 3/16" diameter screws (not provided). Each screw should be of sufficient length to go completely through the NTI mounting ear, rack frame and fully engage all threads in the captive nut. Be sure to tighten all mounting screws securely.
4. Attach all cables securely to the switch and where necessary supply adequate means of strain relief for cables.

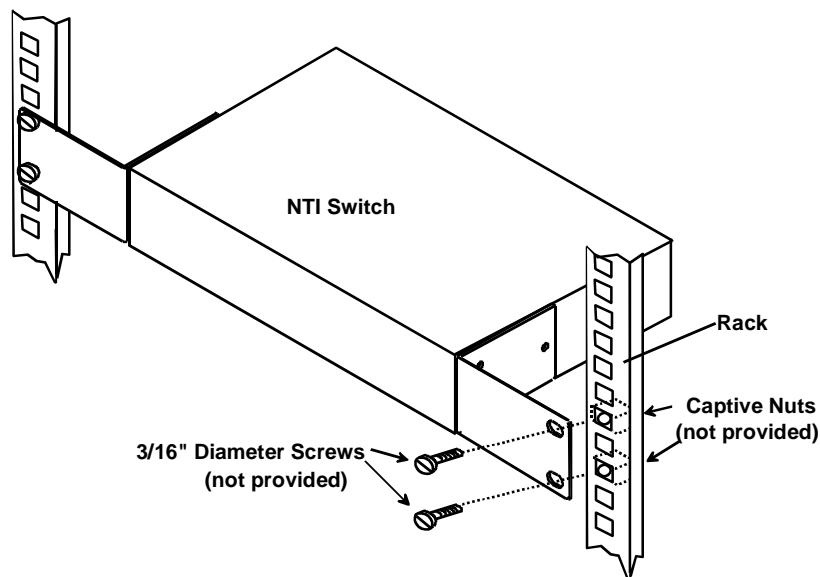

Figure 3- Secure switch to a rack

INSTALLATION

1. It is not necessary to turn the CPUs or monitors OFF during this installation.
2. Connect the cable from a monitor to the HDMI connector labeled "HDMI OUT" on the UNIMUX (See Fig. 4 below.)

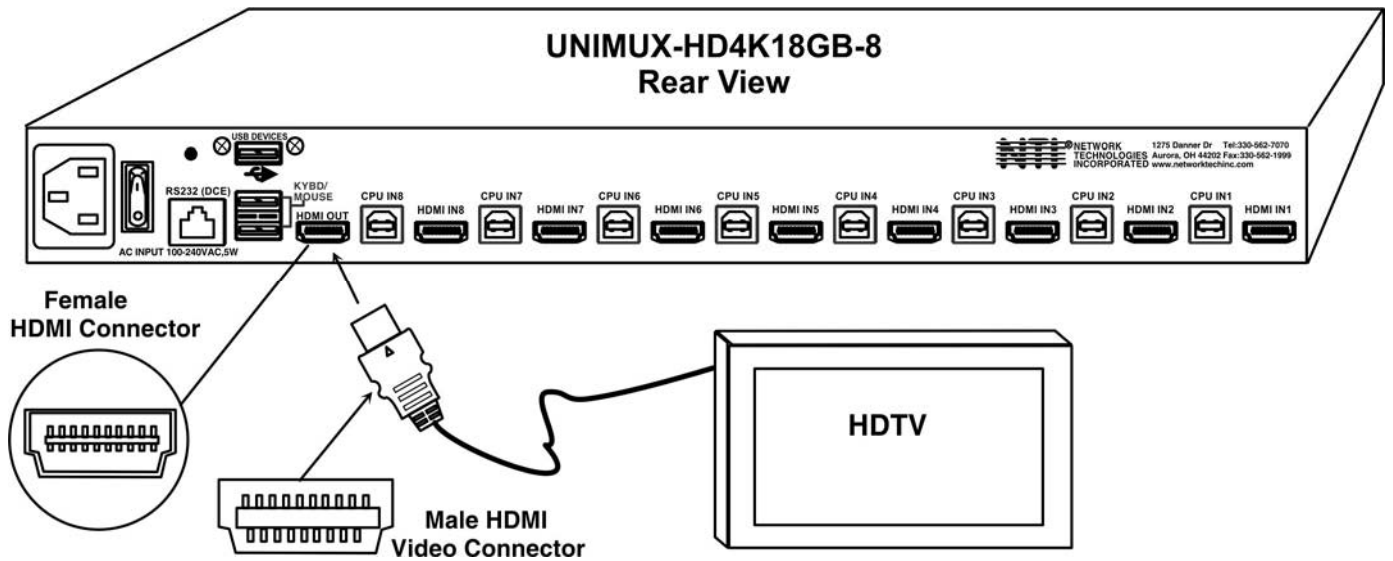

Figure 4- Connect a HDTV monitor

3. Connect the male USB type A connector on the keyboard cable to either one of the two USB type A female connectors labeled "KYBD/MOUSE" on the rear panel of the UNIMUX.
4. Connect the male USB type A connector on the mouse cable to the remaining USB type A female connector labeled "KYBD/MOUSE".

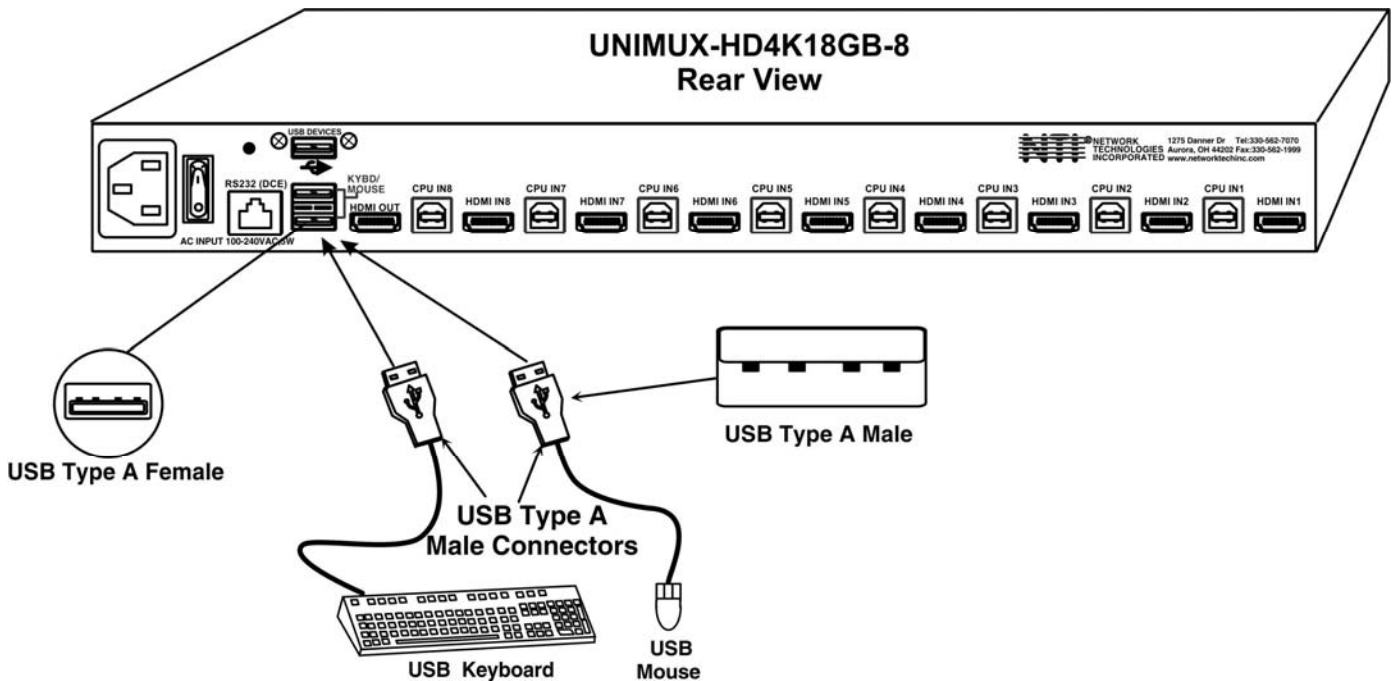

Figure 5- Connect the device(s)

5. Connect the AC line cord to the UNIMUX. (See Fig. 6 below.)

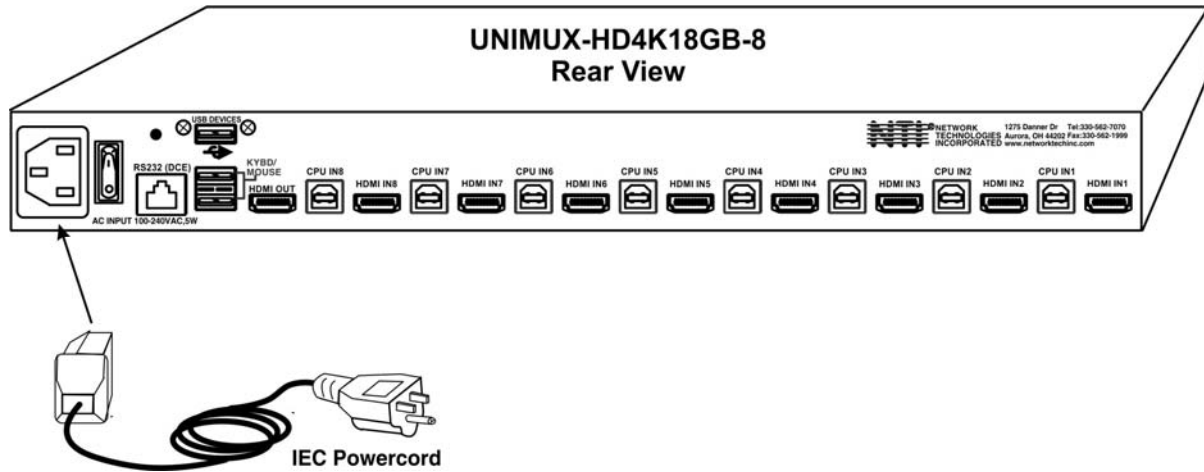

Figure 6- Connect the AC line cord

6. Connect each CPU to the USB switch using a HD-xx-MM video and USB Type A-B device cable – REQUIRED (not supplied). (See Figure 7 below.)
7. Group the input device and monitor interface cables from each CPU, making sure that cables from the first CPU are connected to the UNIMUX at connectors "CPU IN1" and "HDMI IN1". Cables from the second CPU should connect to "CPU IN2" and "HDMI IN2" connectors...etc.

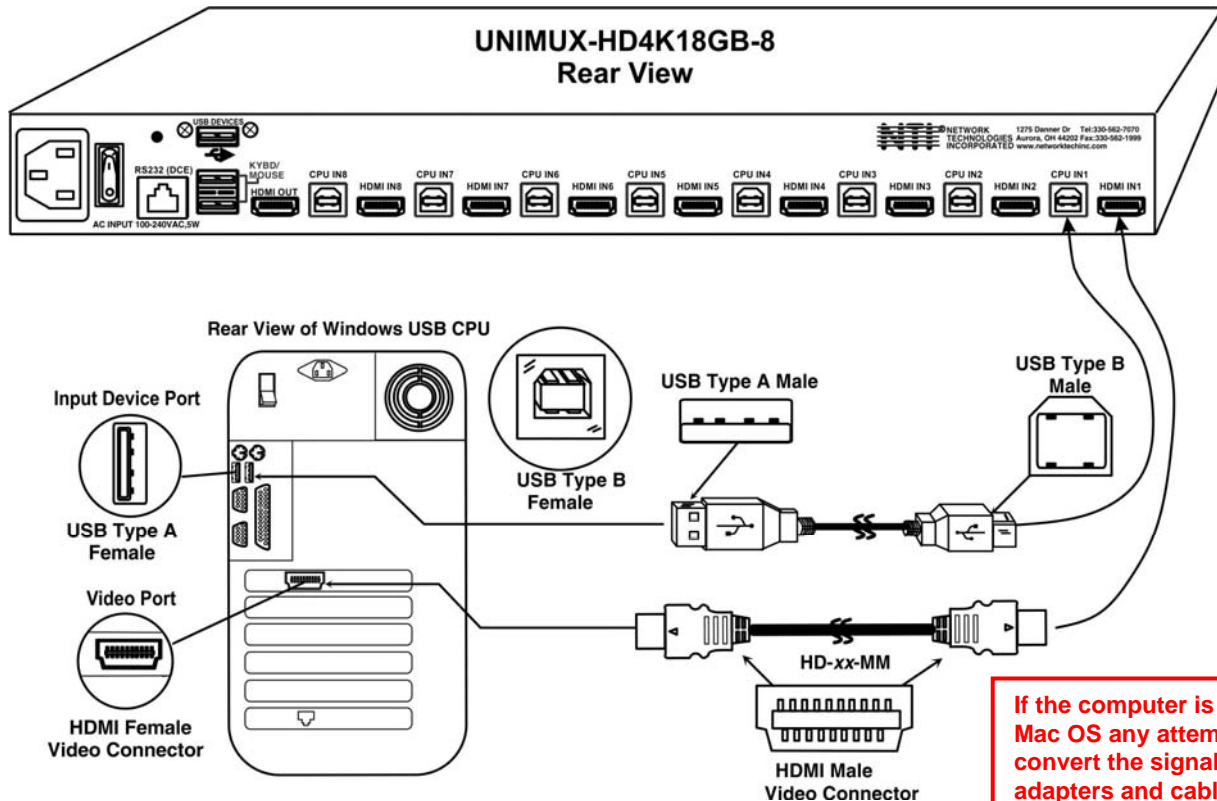

Figure 7- Connect each CPU

NOTE: For 4Kx2K @ 30Hz resolution, use maximum 30 foot HD-xx-MM cables
 NOTE: For 4Kx2K @ 60Hz resolution, use maximum 10 foot HD-xx-MM cables
 NOTE: For 1080p resolution, use maximum 50 foot HD-xx-MM cables.
 NOTE: DVI-HD-1/2/3/5M-MM cables also work supporting resolutions up to 1920x1080@60Hz.

RS232 Connection

If the RS232 is going to be used, connect one end of the CAT5 patch cable (supplied) to the port labeled “RS232” on the rear of the UNIMUX. Plug the other end of the CAT5 cable into the RJ45-to-DB9 adapter (supplied), and connect the adapter to the RS232 port on the control terminal. Follow the instruction under “RS232 Control” on page 19 for configuration and use of the RS232 control feature.

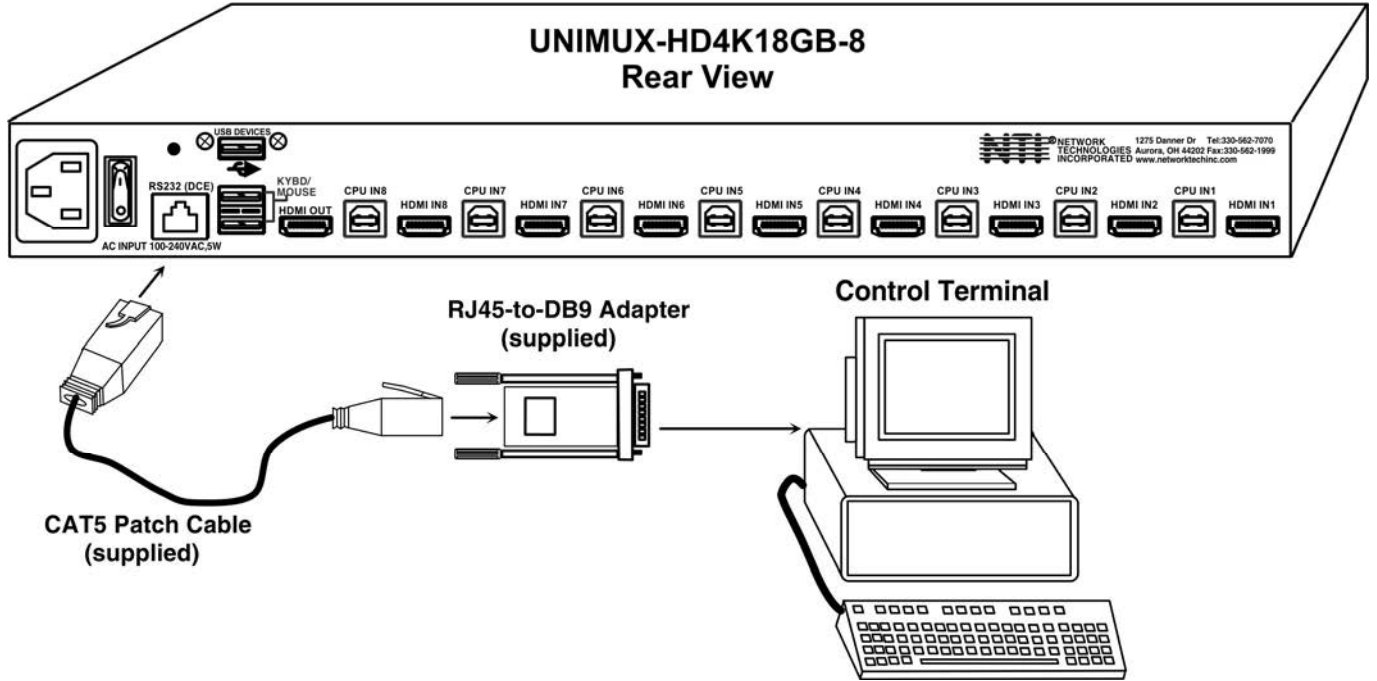

Figure 8- Connect Terminal for RS232 Control

Power-Up Sequence

- The UNIMUX can be powered at any time.
- The CPUs can be powered at any time although if a CPU needs a keyboard and/or mouse at power-ON it should be powered after connecting to and powering-ON the UNIMUX.
- USB input devices (keyboard and mouse) can be hot plugged to and from the UNIMUX at any time.

Approximately 5 seconds after powering ON the UNIMUX, the following splash screen will appear on the monitor:

Once the splash screen goes away, the UNIMUX is booted up and the monitor connected to Port 1 will display the desktop image for the connected CPU. The user can continue with normal operation of the connected CPU.



©2023 Network Technologies, Inc.
All rights reserved

Firmware version 1.00 PROM format 1.00

Limitations

- If the computer is running a macOS, converting the output connector more than once will not work. I.e., USB Type C to HDMI and then back to DVI for the monitor.
- Only USB input device or hub cables can be connected to the UNIMUX at the USB Type A female ports labeled "KYBD/MOUSE". (See Features and Functions on page 2, item 8.)
- A USB hub (single or multi-port) can be used provided only USB input devices are plugged into it.
- Only a USB Windows keyboard or USB mouse may be connected to the USB port on a USB MAC keyboard
- A maximum of 7 devices (including hubs) may be connected to the UNIMUX directly.

See Figure 9 for some examples of input device combinations that can be used with the UNIMUX.

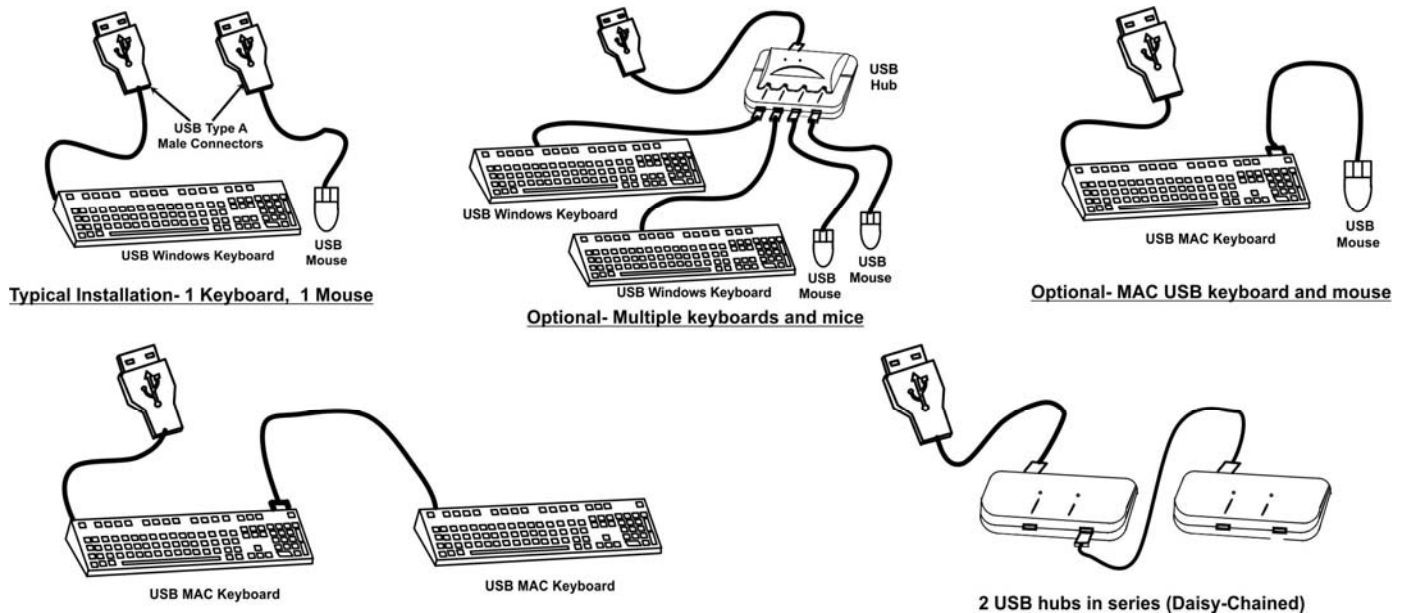

Figure 9- Compatible device combinations

USING THE UNIMUX SWITCH

Once the UNIMUX is properly connected, the UNIMUX will enable a connection to be made between the CPUs attached to its VIDEO and CPU ports and the monitor and input devices attached to the MONITOR and DEVICES ports. The LEDs on the control panel of the UNIMUX will illuminate depending on which port (and corresponding CPU) is being connected to the monitor and input devices.

The UNIMUX can be controlled by four methods:

- front control panel using touch-switches and LEDs
- keyboard control through Command Mode
- mouse clicks from within some menus of Command Mode
- RS232 commands

Front Panel Control

There is a touch-switch and LED on the front panel of the UNIMUX for each CPU the switch will connect the monitor and input devices to. Pressing any touch-switch on the front panel of the UNIMUX will connect the corresponding CPU to the monitor and input devices.

Holding down any front panel touch-switch for more than 2 seconds will cause the UNIMUX to cycle through all modes of operation including COMMAND, BROADCAST, SCAN, and NORMAL (described in "User Access Functions" beginning on page 11). The three MODE LEDs on the front panel indicate which mode is selected. Release the touch-switch when the LEDs indicate the desired mode. When no mode LEDs are illuminated the user is in Normal Mode controlling directly the CPU to which the user is connected through the UNIMUX.

Keyboard Control

Keyboard control of the UNIMUX can be achieved using Command Mode (only from the keyboard attached to the "KYBD/MOUSE" ports)- operated using the keyboard and mouse in conjunction with OSD menus superimposed onto the monitor.

By pressing <Ctrl> + <`> (accent key), the user can enter Command Mode. Once in Command Mode, typing a series of commands will cause the UNIMUX to connect the user to any one CPU connected to the switch. Pressing the <Esc> key will exit Command Mode.

USER ACCESS FUNCTIONS

Command Mode

When entering the Command Mode from the keyboard using the <Ctrl> + <`> (accent key), the OSD menu will automatically appear on the monitor in addition to illuminating the COMMAND indicator LED on the USB KVM switch. This provides a visual way to control the UNIMUX.

Navigation

Keyboard Key	Action
Up/Down Arrow	Select previous or Next port (while in the Port List)
Page Up/Down	Advance to previous or to the next page of the Port List
Home	Select the first port in the displayed port list
End	Select the last port in the displayed port list
<number>	Select and switch to Port Number
Enter	Execute that selection
Shift-Tab	Move to previous field in the menu
Tab	Move to next field in the menu
Space	Toggle the selection of the highlighted field
F1	Bring up the Help Menu (see Figure 11)
Esc	Back up in the menu to the previous page or Exit the OSD menu

The mouse can also be used to control the UNIMUX within the Command Mode menu.

- The mouse cursor can be moved to anywhere on the OSD menu. Text in blue is selectable. The user can then single-click the left mouse button to make a selection, double-click to perform that function.
- Ports listed on the screen can be selected by moving the cursor onto that port and clicking. If the USB Device Reminder is enabled, an additional press of the <Enter> key will be needed (unless you press <Esc> and cancel the change).

Note: When switching ports, there will be a 4.5 second delay (@30Hz) or 7.5 second delay (@60Hz) to see the result on the monitor.

- To scroll through the displayed ports on the screen simply click on the up and down arrows located to the right of the port names displayed.

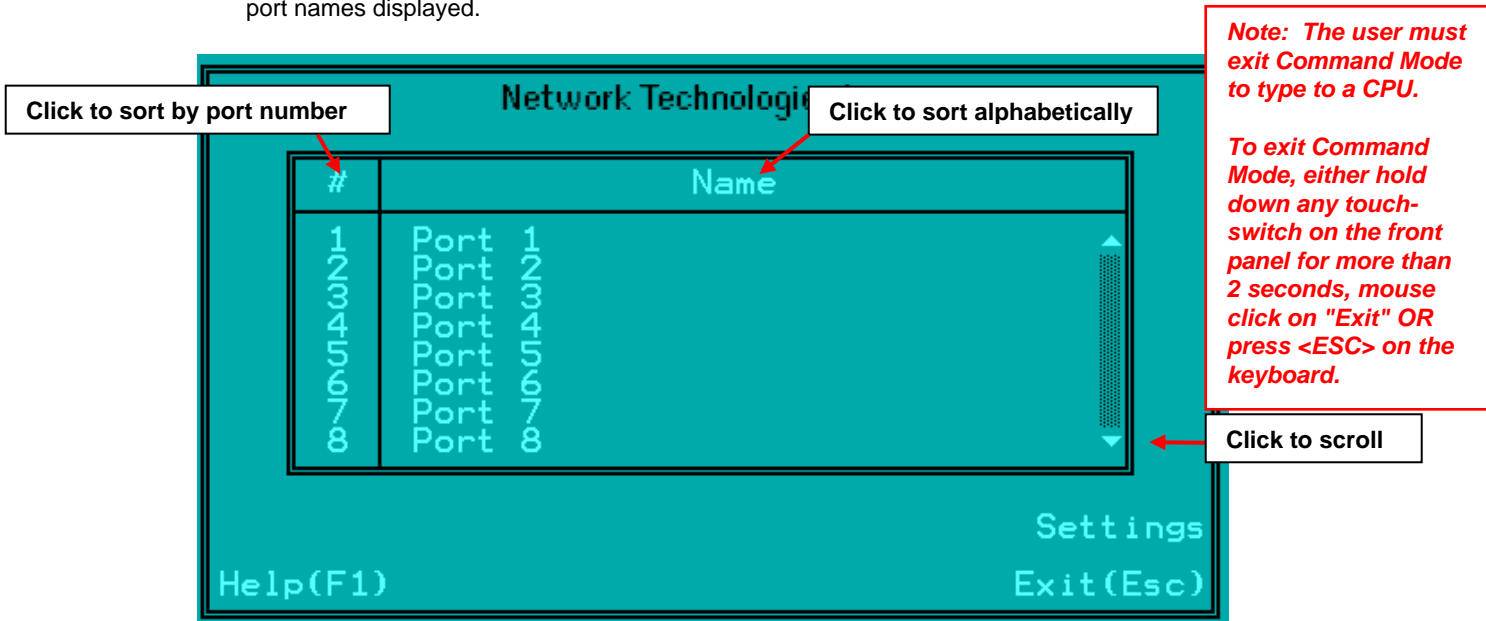

Figure 10- Port List (Main Menu)

To change the way the port list is displayed, the user can click on the "#" sign to have the list displayed numerically, or click in "Name" to have the list displayed alphabetically. If the user decides to rename the ports to something easy to remember, listing them alphabetically may be the most desired setting.

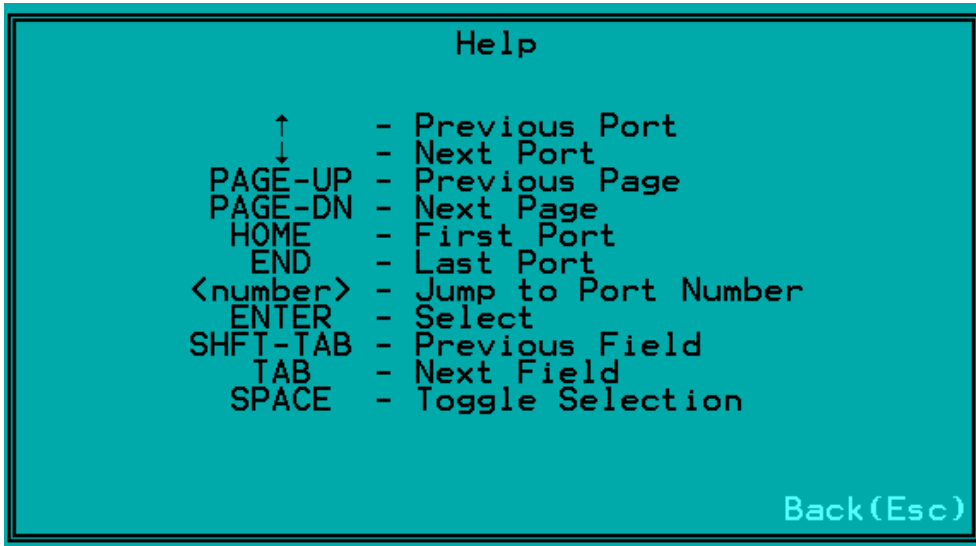

Figure 11- Help Menu

Settings Menu

From the Settings Menu the user can quickly change the status of the major functions in the UNIMUX.

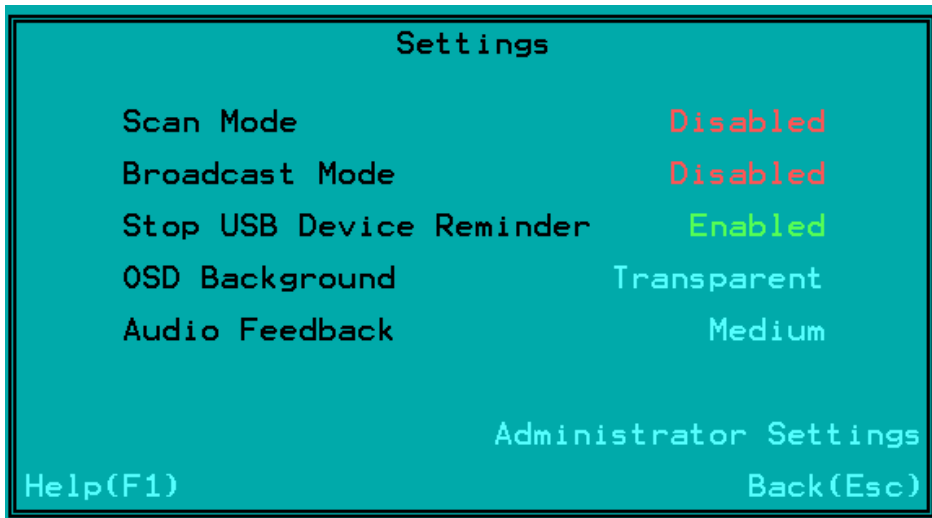

Figure 12- Settings Menu

The user can change the status of Scan Mode and Broadcast Mode between Disabled (red text) and Enabled (green text). Click on the status indicated to toggle it.

The user can enable or disable the "Stop USB Device" Reminder notice. While enabled, any time the user attempts to change to a different port number, a warning message will pop up forcing a decision to either proceed with or cancel the attempt. This provides opportunity for the user to properly eject a USB flash drive (or any other device) that may be harmed by an abrupt loss of connection between the user and the PC the flash drive is connected to.

To respond to the Stop USB Device warning, either click "Enter" or "Esc" with the mouse, or use keyboard keys.

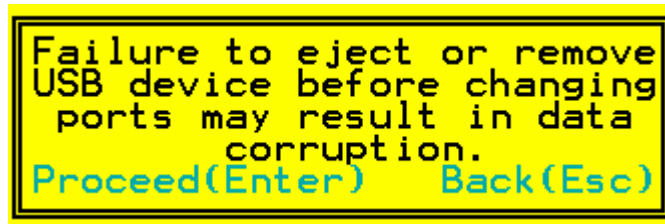

Figure 13- Stop USB Device Reminder warning

From the Setting Menu the user can also toggle the OSD menu to either be Opaque (have solid color) when on the display, or to be transparent (see-through). Click on the setting to toggle it.

The user can also adjust OSD audio feedback volume from low, to medium, to high or just disable it.

Broadcast Mode

Broadcast Mode enables the user to select specific ports (see Figure 15) to be active in Broadcast Mode. Only the selected ports will receive keyboard messages in Broadcast Mode.

To activate or deactivate Broadcast Mode from the Command Mode menu, from the main menu click on Settings. From the Settings menu, click to display either Disabled (deactivated) or Enabled (activated).

Broadcast Mode enables the user to type characters to more computers simultaneously. From the Administrator Settings-Broadcast List menu (see page 19) the user can edit the list of ports that receive data in Broadcast Mode. A port doesn't receive broadcast data if the port is not in the Broadcast Mode list.

Note: The user must type somewhat slowly when in Broadcast Mode (less than 20 wpm).

Note: While in Broadcast Mode the mouse will not work.

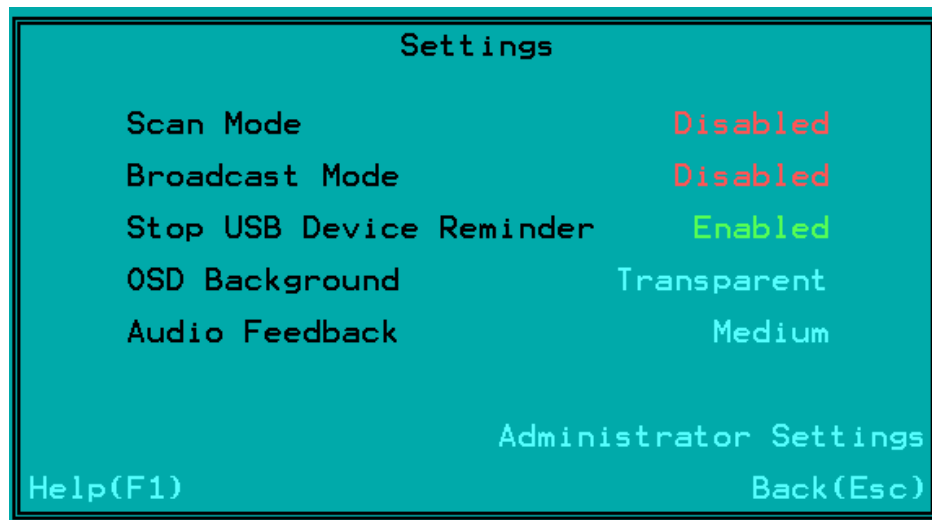

Figure 14- Settings Menu

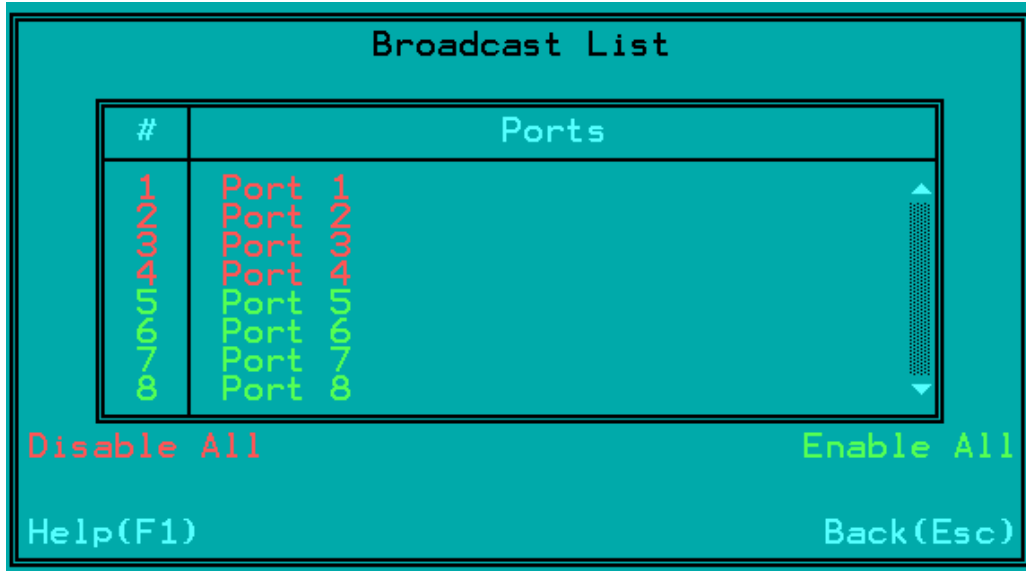

Figure 15- Broadcast List

From the Broadcast List, click on a port number to toggle its status. Ports displayed in green are included in the broadcast, ports in red are not. To quickly select all ports, click on "Enable All". To quickly deselect all ports, click on "Disable All". Selections are automatically saved.

Scan Mode

Scan Mode enables the user to select specific ports (see Figure 17) to be active in Scan Mode. Only the selected ports will be scanned in Scan Mode.

To activate or deactivate Scan Mode from the main menu click on Settings. From the Settings menu, click to display either Disabled (deactivated) or Enabled (activated).

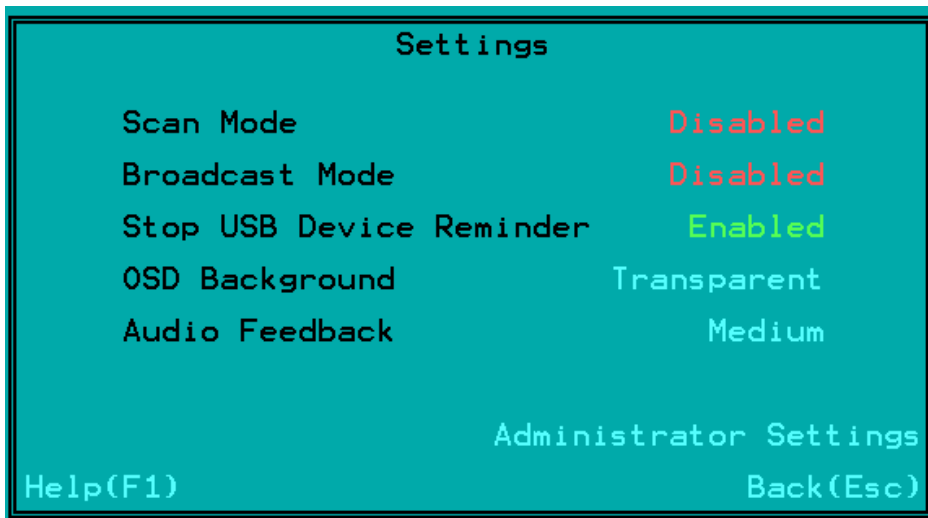

Figure 16- Settings Menu

When in Scan Mode the switch scans to each port selected in the Scan List. (The SCAN LED on the front panel will illuminate and remain ON while in Scan Mode.) Scan mode will connect to the selected ports, whether those ports are powered ON or not. The ports with the CPU powered-ON remain active while in use until becoming idle for the configured dwell time (Figure 17) (default time-out period is 15 seconds) before switching to the next selected CPU port. See Command Mode section above for configuring the scan dwell time.

Note: The keyboard and mouse must remain idle for the full scan dwell time before the switch selects the next active port.



Figure 17- Scan List

From the Scan List, click on a port number to toggle its status. Ports displayed in green are included in the list to be scanned, ports in red are not. To quickly select all ports, click on "Enable All". To quickly deselect all ports, click on "Disable All". Selections are automatically saved.

Click on the number next to "Dwell Time" to select the field and enter a number between 0 and 255 (default is 15) to configure the length of time the connection will remain with a CPU before switching to the next CPU while the UNIMUX is in Scan Mode.

Normal Mode

When the UNIMUX is not in Command, Broadcast, or Scan mode and all of the UNIMUX mode LEDs are OFF, the user is in Normal Mode, controlling the CPU to which the user is connected through the USB KVM switch.

Administrator Settings

The Administrator Settings menu provides access to specific administrative functions of the UNIMUX. From the Main Menu select Settings, then Administrator Settings.

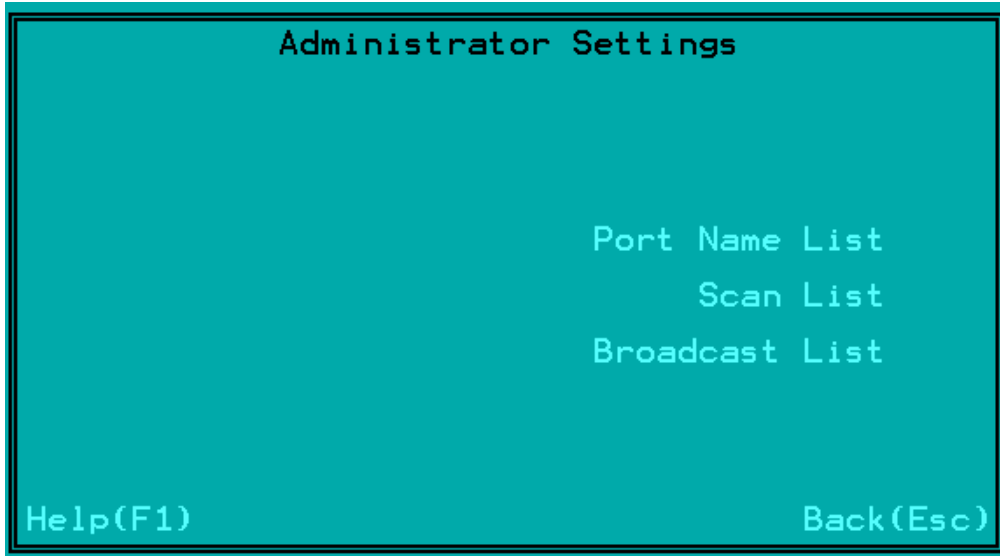

Figure 18- Administrator Settings

Click the Port Name List to bring up a page where the names displayed for the UNIMUX and for each port can be edited.

Clicking on the Port Name List or Scan List will bring up the list of ports that can be set to be affected by Broadcast and Scan modes (pages 13 and 14)

Port Name List

The Port Name List is provided to enable the user to edit the names of the ports and switch. Port names and the switch name can be up to 32 characters in length. The user can customize the UNIMUX to make switching to frequently used ports more easily. The Port Name List is accessed from the Administrator Settings menu (page 16).

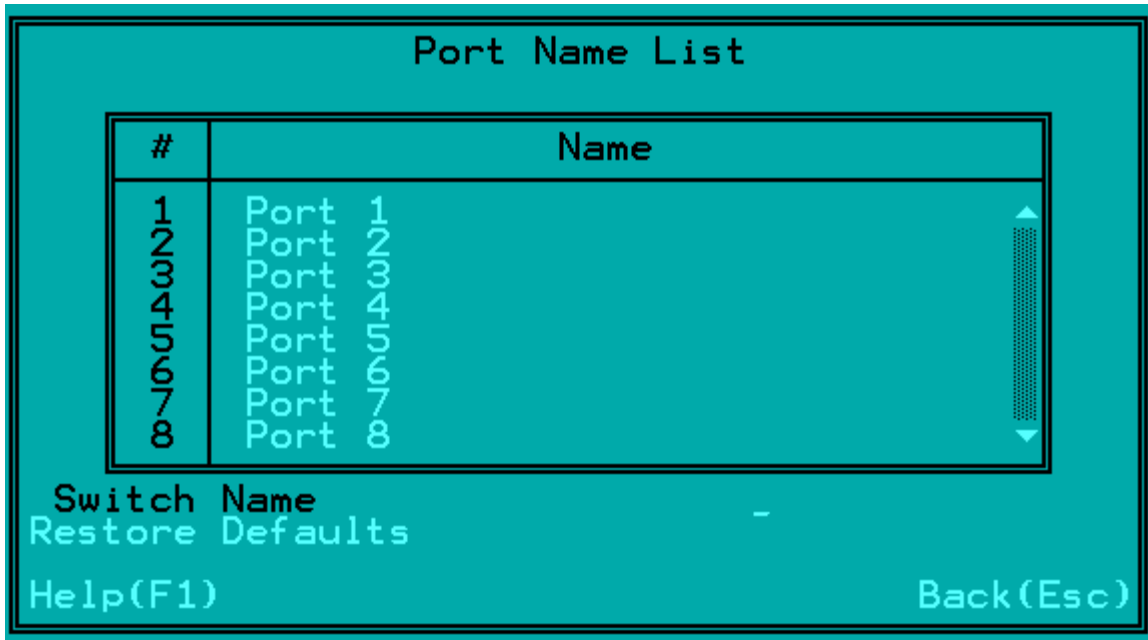

Figure 19- Port Name List

To quickly return the switch to factory settings for the switch name, port names, and all configured settings, click on "Restore Defaults".

To Edit the Switch name and Port Names:

Using the Keyboard:	Using the Mouse:
1.Press <Tab> to move between fields	1.Click on the field to select it
2.Press <Enter> to select a field to edit	2.Type the text to be used
3.Type the text to be used	3.Press <Enter> to save it
4.Press <Enter> again to save it	

Editing keyboard keys for name fields include: Backspace, Delete, Right Arrow, Left Arrow, Home, End and Insert.

Hot Keys

There are 6 key combinations that can be pressed from any OSD screen (except the Help screen) that will have an immediate effect, for quick navigation through the Command Mode menus. Pressing the keys will help to quickly take you where you want to go in the OSD menus or to change the state of Broadcast and Scan modes.

Keyboard Key Sequence	Action
Ctrl + s	Toggle Scan Mode ON/OFF
Ctrl + b	Toggle Broadcast Mode ON/OFF
Ctrl + e	Jump to Port Name List screen
Ctrl + m	Jump to Settings screen
Ctrl + t	Jump to Admin Settings screen
Ctrl + p	Jump to the Main OSD screen

When toggling Broadcast and Scan modes, the action can be seen on the Settings screen in the status change from "Disabled" to "Enabled" and back again (see Figure 20). It can also be seen on the front panel with the illumination or lack of illumination of the Broadcast or Scan mode LEDs (see Figure 21).

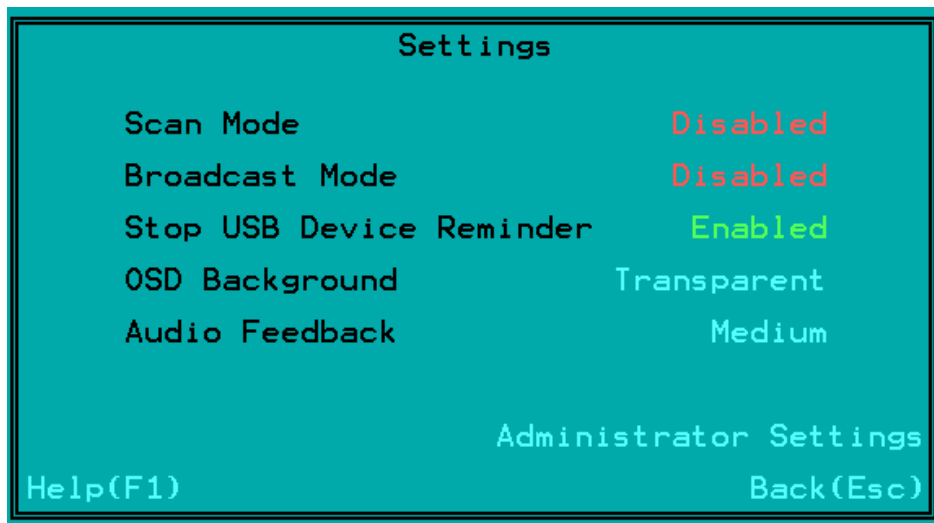

Figure 20- Settings Menu

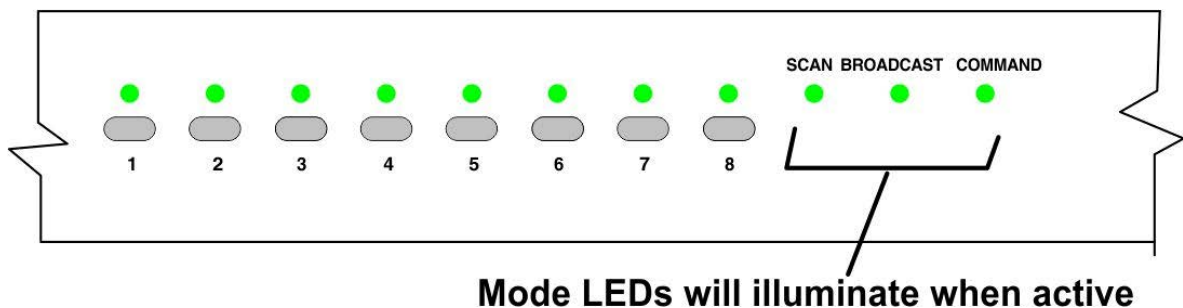

Figure 21- Front Panel Mode LEDs

RS232 CONTROL

RS232 enables the UNIMUX to be remotely controlled via RS232. To control the UNIMUX via RS232 the user has three options:

- use a terminal program (e.g. HyperTerminal) from a PC connected to the RJ45 “RS232” port (page 8)
- use the NTI Switch Control Program (page 20)
- use the SerTest program (page 21)

RS232 Connections and Configuration

Remote Connection

The RS232 Interface (optional) is designed to meet the RS232C standard and can be controlled from any CPU or other controller with an RS232 communications port. The pin-out for the RJ45 connector on the unit is as follows:

RS232 (RJ45) CONNECTOR

PIN	SIGNAL	FUNCTION
1	-	No connection
2	-	No connection
3	RX+	Receive data (TXD at host)
4	GND	Ground
5	-	No connection
6	TX+	Transmit data (RXD at host)
7	-	No connection
8	-	No connection

A 5 foot patch cable and adapter, RJ45-to-DB9, has been provided for connection to most CPUs (see page 8).

Baud Rate

The default application baud rate for the UNIMUX is 115200. This can be changed to 1200,2400,4800,19200,38400,57600 or 115200 using RS232 control commands.

Note: When performing a firmware upgrade, the baud rate will always be 115200, regardless of what the application baud rate has been set to.

Command Protocol

RS232 commands supported by the unit are defined below. All command strings should be terminated with a <CR> (carriage return). When a command is sent, the entire string is echoed back along with a response from the addressed unit as shown in the command definitions. All characters in the command string should be upper case, and all numbers below 10 should have a leading 0 (ex: 1 = 01).

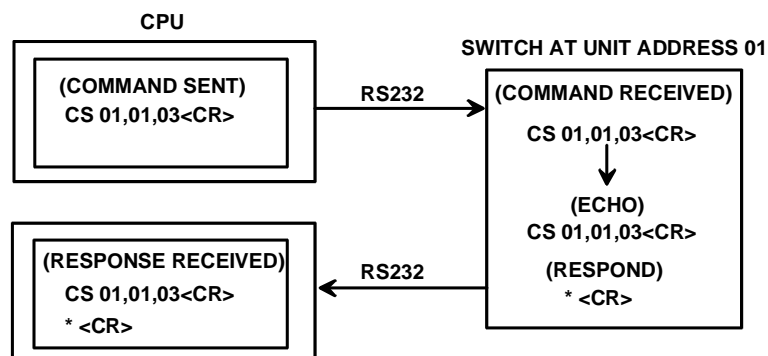

Figure 22- RS232 Communication Illustrated

Legend: (All numbers must be two digits)

- OP : Output (User) Port (01)
- IP : Input (CPU) Port (01-MAXINPUTS)
- BR : Baud Rate= **1200,2400,4800,9600,19200,38400,57600 or 115200**
- <CR> : Carriage Return (Hex 0xD)
- 01 : Switch serial address designator (cannot be changed)

Command Definitions

Command String	Good Response	Description
CS 01,IP,OP	*<CR>	Connect Input (CPU) Port To specific Output (User) Port
CB 01,BR	*<CR>	Change the baud rate (12=1200, 24= 2400, 48=4800, 96= 9600, 19=19200, 38=38400, 57=57600, 11=115200)
RV 01, 00	*<CR>	Returns firmware version and PROM format (like page 9)
RO 01,OP	*<CR>IP<CR>	Read Connection For Output (User) Port to Input (CPU) Port
RU 01	*<CR>IP,OP<CR>	Read Unit Size

If the first field is not a known command (as listed above) the command will be ignored. If the syntax is wrong after this field, the switch will answer with a bad response ?<CR>.

Syntax example:

CS 01,05,01<CR> (insert the space and commas as shown)
 which means "At the switch with unit address 01, connect CPU port 05 to user port 01"
 The switch will answer with:
 *<CR>

NTI Switch Control Program For Windows 7, 8,10 and 11

The NTI Switch Control Program is an easy and powerful graphical program that controls NTI switches through an RS232 interface. The NTI Switch Control Program can be downloaded from <http://www.networktechinc.com/srvsw-usbu.html#tab-6>

To install the NTI Switch Control Program after downloading

1. Locate the **Setup.exe** in the directory the program was downloaded to and double-click on it
2. Follow the instructions on the screen

Note: In order to use the NTI Switch Control Program to control the UNIMUX, the UNIMUX RS232 port must be set at a baud rate of 9600 bps.

The NTI Switch Control Program performs best on monitors set to a screen resolution of at least 800 X 600. Instruction for using the NTI Switch Control Program is available by opening "MSCP Help" in the "NTI" program group once the program has been installed and is open on the screen.

To open "MSCP Help" from the Windows desktop

1. Click on **START**
2. Click on **PROGRAMS**
3. Click on **NTI**
4. Click on **MSCP Help**

SerTest- RS232 Interface Test Program

This software allows a user to test the functions of an NTI server switch, matrix switch or Multi-user/Multi-platform/Single-user switch RS232 interface. The SerTest program is automatically loaded when installing the NTI Switch Control Program as described above. The SerTest program, located in the NTI program group, generates a main menu with the 4 selections described below:

Main Options

- Matrix Operations - send commands to the unit.
- Ethernet Operations - set Ethernet connection variables (not applicable to this model)
- Setup Options - set COM port, baud rate, and unit address
- About SerTest - display the program version

If Matrix Operations is selected, the following menu is displayed:

SWITCH OPERATIONS

- 1) Reset Unit (not applicable to this model)
 - send a reset command to the switch
 - the current unit address is displayed in parentheses
- 2) Reset All Units - send an internal reset command to all switches (not applicable to this model)
- 3) Connect Output/User to an Input/CPU
 - connect an output to an input
- 4) Connect All Outputs/Users to an Input/CPU (not applicable to this model)
 - connect all outputs to an input
- 5) Connect Audio Output/User to an Input/CPU (not applicable to this model)
 - connect an output to an input
- 6) Connect All Audio Outputs/Users to an Input/CPU (not applicable to this model)
 - connect all outputs to an input
- 7) Change Mute Status for Audio Output/User (not applicable to this model)
 - mute or un-mute the Audio port output
- 8) Change Volume for Audio Output/User (not applicable to this model)
 - change Audio port output volume
- 9) Read Connection for Output/User
 - read what input is connected to the specified output
- a) Read Connection for Audio Output/User (not applicable to this model)
 - read what input is connected to the specified output
- b) Read Mute Status and Volume for Audio Output/User (not applicable to this model)
 - read the volume and the mute status of the specified output
- c) Read Unit Size
 - read the switch size (number of inputs and outputs)
- d) Read Unit Version/Revision String (not supported by this model)
 - read a string containing the switch version, type, and size
- e) Save I/O Connections into Unit Memory (not applicable to this model)
 - save the connections into switch memory bank
- f) Restore I/O Connections from Unit Memory (not applicable to this model)
 - restore the connections from switch memory bank
- g) Save All Units I/O Connections into Units Memory (not applicable to this model)
 - save the connections into switch memory bank, command for all switches

- h) Restore All Units I/O Connections from Units Memory (not applicable to this model)
 - restore the connections from switch memory bank, command for all switches
- i) Change All Units Baud Rate (9600/COM1) (not applicable to this model)
 - change RS-232 Baud rate of all switches
 - the current baud rate and serial port are displayed in parentheses

ETHERNET OPERATIONS (not applicable to this model)

SETUP OPTIONS

- 1) Select Com port current: (COM1:)
 - select PC serial port
 - the current PC serial port is displayed in parentheses
- 2) Select Baud rate current: (9600)
 - select PC serial port baud rate
 - the current baud rate is displayed in parentheses
- 3) Set unit Address current: (1)
 - select the unit address of the switch to be connected to by this program
 - the current address is displayed in parentheses

For any selection that requires user input, the user is prompted. When commands are sent to the UNIMUX, the command string and UNIMUX responses are echoed to the screen. All commands generated by the program are formatted according to the information provided in sections above. If any transmission problems are detected, an error message is displayed.

Press <Esc> or <Enter> to back out to the main menu and press again to exit.

Firmware Update

RS232 is also used when upgrading the firmware for the UNIMUX. To upgrade the firmware, the user must first access the bootloader menu.

To access the bootloader menu,

1. Power OFF the UNIMUX
2. Press and hold the button to the left of the "USB DEVICES" port on the rear of the UNIMUX. While holding the button, power ON the UNIMUX.
3. When you see the bootloader menu on the PC connected to the RS232 port release the button.

Bootloader Rev. 1.0

Build date: Apr 5 2018 10:02:45

Copyright (C)2018 Network Technologies Inc.

Press <H> for help...

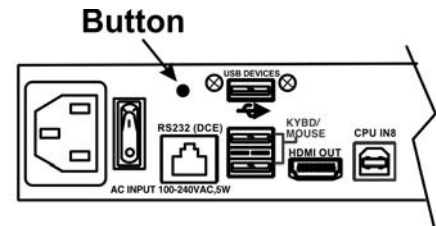

**UNIMUX-HD4K18GB-8
Rear View**

Type <H> + <Enter> to display the commands menu:

When entering the command character for the desired function, an upper or lowercase character may be used. Simply type the character associated with the function, and press <Enter>.

>

>h

Commands:

- h, H - Display list of commands
- a, A - Reset administrator password to default
- d, D - Reset configuration to factory default
- u, U - Update application firmware
- i, I - Load PROM image
- x, X - Exit administrator mode

>

The bootloader menu can be used for updating firmware, resetting the UNIMUX to factory default settings, and resetting the administrator password to default (no password is used as of this printing).

>a

Resetting administrator password...

Done

```
>d
Restoring configuration to default. Please wait.....
.....
```

```
>u
```

```
Erasing application memory...
Send .hex file using XModem protocol...

File transfer OK!
```

```
>i
```

```
Send .bin file using XModem protocol...
Configuration image file successfully programmed
```

```
>
```

Two files can be updated in the firmware configuration of the UNIMUX. Both files will be downloaded (to the PC that is connected via RS232) with the most current version of code for the firmware download page for this product, <https://www.networktechinc.com/4k-hdmi2-usb-kvm-switch.html>.

There are no firmware update files available as of this printing.

Filenames will be similar to *prom_unhd4k18gb_vx-xx.bin* and *appupdate_unhd4k18gb_vx-xx.hex*. (x-xx = the version number). Check the release notes as to whether one or both files are updated from one version to the next (most of the time the .bin file **will not** be updated).

When using the u command, you will be prompted to send the .hex file. At the point, from the Terminal program, search for and send the *appupdate_unhd4k18gb_vx-xx.hex* using XModem protocol. When the transfer is complete, you will see the message "File transfer OK!". Now either type <X> or power cycle the UNIMUX.

If the release notes call for updating the .bin file, use the i command in the same fashion and send the *prom_unhd4k18gb_vx-xx.bin*. Upon completion, you will receive the message "Configuration image file successfully programmed". Again, either type <X> or power cycle the UNIMUX.

KEYBOARD FEATURES

The keyboard configuration of each CPU is saved in the UNIMUX. For example, if the CPU attached to Port 2 had CAPS LOCK and NUM LOCK selected the last time that CPU was accessed, then they will automatically be set when that CPU is accessed again.

Keyboard-To-Computer Translation

The UNIMUX enables a mixture of otherwise incompatible peripheral computer components to be connected together. This is accomplished by performing keyboard-to-computer translations automatically (i.e. translate a MAC keyboard and mouse to a Windows type CPU). The chart below shows the capabilities of devices controlling Windows CPUs.

Translation Capabilities

Device	CPU
	Windows
AT101 Keyboard	Full functionality
Mac keyboard	Full functionality-except Application Key
Apple Pro Keyboard	Full functionality
Wheel Mouse	Full functionality

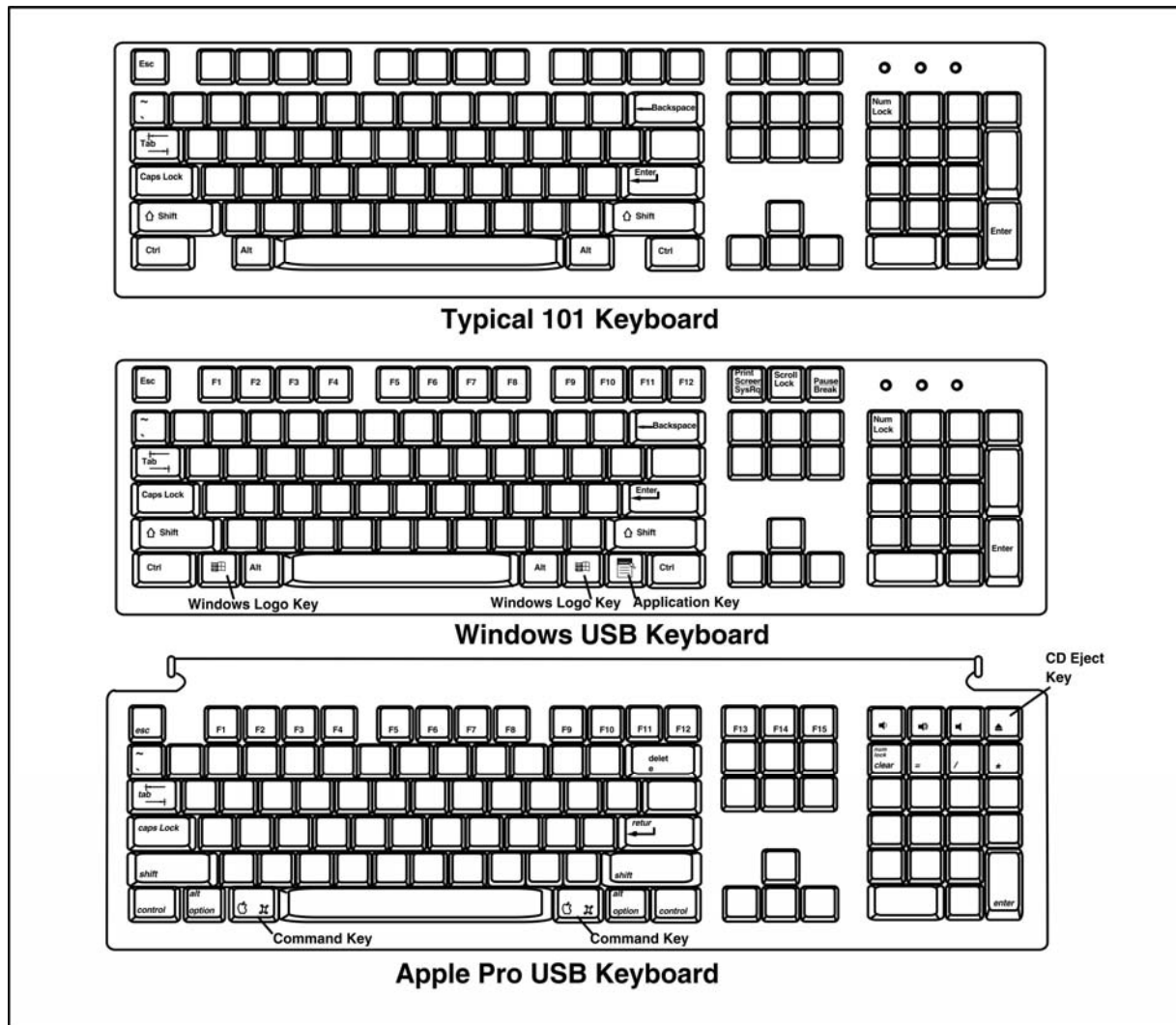

Figure 23- Keyboard Layouts

TROUBLESHOOTING

PROBLEM: Keyboard Errors

SOLUTION: Check cable connections on each CPU and the switch.

PROBLEM: No Video

SOLUTION: Check cable connections on each CPU and the switch. Verify that keyboard and video connect from each CPU to matching ports. After reconnecting, CPU may need to be re-booted in order to sense the monitor connection.

PROBLEM: No Mouse Movement

SOLUTION: Check cable connections of mouse. Verify that mouse driver was loaded.

SOLUTION: Broadcast Mode is ON. Turn OFF Broadcast Mode.

PROBLEM: No RS232 communication

SOLUTION: Using null modem cable. Change cable to one with pins wired straight-through

PROBLEM: No keyboard and mouse

SOLUTION: Unit is in Command Mode. Press <Esc> key until Command Mode LED on UNIMUX is OFF

SOLUTION: USB lock-up- Hot plug the keyboard and mouse

SOLUTION: USB lock-up- Hot plug the USB cable from the computer

SOLUTION: UNIMUX lock-up- Power cycle the UNIMUX switch

PROBLEM: DVI Monitor does not display an image, reports "Out of Range"

SOLUTION: EDID table from monitor has not been communicated to source. Connect DVI monitor directly to source first using an HDMI to DVI adapter cable(NTI# DVI-HD-xM-MM) (or DP to DVI adapter cable (NTI# DP-DVID-xx-MM) if the source is DisplayPort), adjust the resolution to one that works with the monitor, then put the UNIMUX-HD4K18GB-x in between again.

TECHNICAL SPECIFICATIONS

Hosts	
Connectors	Female HDMI-A, Female USB Type B
Max. Resolution supported	2560x1440 (computer), 3840x2160 (UHD), and 4096x2160 (4K) @ 60Hz / 4:4:4 RGB ; 1920x1080@60Hz/1920x1200@60Hz using HDMI to DVI cable
HDMI Compatibility	HDMI 2.0, DVI compatible (with optional HDMI to DVI cable).
HDCP Support	V2.2
Multiplatform support	Windows 7/8/10/11, Windows Server 2008/2012/2016/2019/2022, Linux, FreeBSD, and macOS 10/11/12/13.
Switching delay time	4.5 seconds @4k30Hz 7.5 seconds @4k60Hz
Supports USB-enabled computers	PC and MAC (with HDMI video).
Monitor	
Max. Resolution supported	Ultra-HD 4Kx2K resolutions to 3840x2160 and 4096x2160 @24/30/60Hz RGB/YUV 4:4:4, HDTV resolutions to 1080p (120Hz), and up to 1920x1200 (WUXGA).
Connector	One female HDMI-A connector
HDMI and HDCP Standards	Compliant with HDMI 2.0 and HDCP 2.2
Devices	
Connectors	Two Female USB 1.1 Type A for Keyboard and Mouse Supports full-speed (12Mbps) or low-speed (1.5Mbps) USB keyboard and mouse Compatible with most USB keyboards and mice, including USB IntelliMouse® Keyboard and mouse are hot-pluggable Supports MAC extra keys
Extra USB Support	Two transparent female USB 2.0 Type A connectors for additional USB devices. Supports high-speed (480 Mbps), full-speed (12 Mbps) and low-speed (1.5 Mbps) USB devices including, but not limited to, touchscreen monitors, CAC card readers, printers, scanners, and thumb drives.
General	
Operating temperature	32 to 104°F (0 to 40°C)
Storage temperature	-22 to 140°F (-30 to 60°C)
Operating and Storage Relative Humidity	5 to 90% non-condensing RH
Power	100 to 240 VAC at 50 or 60 Hz via IEC connector
Power consumption	<ul style="list-style-type: none"> • UNIMUX-HD4K18G-4: 14W • UNIMUX-HD4K18G-8: 14W • UNIMUX-HD4K18G-16: 21W • UNIMUX-HD4K18G-24: 28W • UNIMUX-HD4K18G-32: 35W Note: The combined current consumption of the connected USB devices cannot exceed 1.0A.
Regulatory Approval	CE, RoHS, TAA Compliant
Dimensions (WxDxH)	
UNIMUX-HD4K18GB-4/8/16	
Without supplied rackmount kit	15.32x6.82x1.75 in (389x173x44 mm)
With supplied rackmount kit	19x6.82x1.75 in (483x173x44 mm)
UNIMUX-HD4K18GB-24/32	
Without supplied rackmount kit	15.32x8.19x3.5 in (389x208x88 mm)
With supplied rackmount kit	19x8.19x3.5 in (483x208x88 mm) Cable tray adds an additional 3" to the depth.

Cables

Interface cables between the computers/monitor and the switch are required for proper operation.(Cables not included.)

- Supports HDMI cable lengths to 10 feet for 4K@60Hz resolutions and 50 feet for 1080p.
 - Longer cables can be used provided they have a built-in video equalizer (also known as "active HDMI cables").

Use HD-xx-MM cable to connect an HDMI computer or display.

- HD-3/6/10-MM supports resolutions to 4K@60Hz.
- HD-15/20/30-MM supports resolutions to 4K@30Hz.
- HD-50-MM supports resolutions to 1080p.

Use HD-ACT-xx-MM 4K HDMI Active Cables to connect an HDMI source or display up to 100 feet (not included).

- HD-ACT-20/25/30/40/50/60-MM supports resolutions to 4K@60Hz.
- HD-ACT-75/100-MM supports resolutions to 4K@30Hz.

Use DVI-HD-xM-MM to connect a DVI computer or display up to 5 meters.

- Supports resolutions to 1080p.

Use DP-HD-xx-MM to connect a DisplayPort computer up to 10 feet.

- Supports resolutions up to 4k@30hz 4:4:4 and 4K@60Hz 4:2:0.

Use USB3C-HD4K-xx-MM to connect a 4K@60Hz computer with USB Type C connector up to 10 feet.

Use a USB2-AB-x-5T male USB Type A to male USB Type B interface cable to connect a USB computer to the switch. 5-foot (1.5-meter) CAT5e patch cable and RJ45F-DB9F adapter included for RS232 control.

INDEX

baud rate, 17

Broadcast Mode, 12

control methods, 9

front panel control, 9

installation, 5

keyboard configuration, 23

keyboard control, 9

limitations, 8

materials supplied, 1

Rack mounting, 4

RS232 commands, 17

RS232 Control, 17

RS232 pinout, 17

Scan Mode, 13

SerTest, 19

user access functions, 10

WARRANTY INFORMATION

The warranty period on this product (parts and labor) is two (2) years from the date of purchase. Please contact Network Technologies Inc at **(800) 742-8324** (800-RGB-TECH) or **(330) 562-7070** or visit our website at <http://www.networktechinc.com/return-policy.html> for information regarding repairs and/or returns. A return authorization number is required for all repairs/returns.